

Hulk Compactor
Range Manual

Original Instruction Manual

Read instructions before operating tools

Models manual is applicable to:

HULK PETROL

COMPACT24HP

HULK ELECTRO

COMPACT110V COMPACT230V COMPACT230VEU



GB

Model Specifications

Evolution Power Tools reserves the right to make improvements and modifications to the design and technical specification of this product without prior notification.



This manual was originally written in English.

HULK PETROL

HULK PETROL ENGINED COMPACTOR

Engine Type	Single cylinder 4 stroke OHV		
Engine Power (HP)	2.4 @ 3600 min ⁻¹		
Spark Plug Replacement	LD E6TC (available from Evolution)		
	NGK BP6HS		
	CHAMPION L87YCC		
	AC DELCO 42FS		
Spark Plug Gap	0.028 – 0.031 inches		
	0.07 – 0.08 mm		
Air Filter Replacement	Evolution H1S58		
Valve Clearances (cold)	Inlet	0.15 mm	0.006 inches
	Exhaust	0.20 mm	0.008 inches
Compaction Force (kN)	10		
Vibration (m/sec ²)	15.12 K = 1.5		
Sound Power Level (LwA)	101 dB(A) K= 3 dB(A)		
Sound Pressure Level (LpA)	105 dB(A) K= 3 dB(A)		
Recommended Maximum	20		
Operator Usage Time (mins)			
Oil Type	SAE 10W-30/40		
Oil Capacity (litres)	0.25		
	(pints) 0.5 (US)		
Fuel Type	Standard Unleaded Petrol/Gasoline		
Fuel Capacity (litres)	1.2		
	(pints) 2.5 (US)		
Weight (kg) (lb)	38 84		
Handle Height (during operations - extension handle fitted) mm (inches)	1020 (40)		
Machine Reach (during operations - extension handle fitted) mm (inches)	1290 (51)		
Footprint Width mm (inches)	320 (12-1/2)		

HULK ELECTRO

HULK ELECTRO COMPACTOR

Motor	230V or 115V 50/60 Hz 130W		
Motor Speed (min ⁻¹)	2860 (no load)		
Compaction Force (kN)	5		
Recommended Maximum	30		
Operator Usage Time (mins)			
Sound Power Level (LwA)	98.8 dB(A) K= 3 dB(A)		
Sound Pressure Level (LpA)	94 dB(A) K= 3 dB(A)		
Vibration (m/sec ²)	7.43 K = 1.5		
Weight (kg) (lb)	26 57		
Handle Height (during operations) mm (inches)	920 (36)		
Machine Reach (during operations) mm (inches)	1290 (51)		
Footprint Width mm (inches)	320 (12-1/2)		
Cable Length Metres (Feet)	10 (33)		
Insulation Class	II		

IP44



Instruction Manual

Read instructions before operating this tool.

TABLE OF CONTENTS	PAGE
Specification	03
Important Information	05
Evolution Limited Guarantee	05
General Safety Rules	05
Additional Specific Safety Rules	07
Labels and Symbols	11
Machine Overview	12
Getting Started	14
General Operating Advice	20
Maintenance	24
Troubleshooting Guides	25
Long Term Storage	26
Optional Accessories	27
Environmental Protection	27
Parts Diagrams & EC - Declaration of Conformities	28

IMPORTANT

Please read these operating and safety instructions carefully and completely.

For your own safety, if you are uncertain about any aspect of using this equipment please access the relevant Technical Helpline, the number of which can be found on the Evolution Power Tools website. We operate several Helplines throughout our worldwide organization, but Technical help is also available from your supplier.

WEB www.evolutionpowertools.com/register

Congratulations on your purchase of an Evolution Power Tools Machine. Please complete your product registration 'online' as explained in the A5 online guarantee registration leaflet included with this machine. You can also scan the QR code found on the A5 leaflet with a Smart Phone. This will enable you to validate your machine's guarantee period via Evolutions website by entering your details and thus ensure prompt service if ever needed. We sincerely thank you for selecting a product from Evolution Power Tools.

EVOLUTION LIMITED GUARANTEE. EVOLUTION POWER TOOLS RESERVES THE RIGHT TO MAKE IMPROVEMENTS AND MODIFICATIONS TO THE PRODUCT DESIGN WITHOUT PRIOR NOTICE.

PLEASE REFER TO THE GUARANTEE REGISTRATION LEAFLET AND/OR THE PACKAGING FOR DETAILS OF THE TERMS AND CONDITIONS OF THE GUARANTEE.

Evolution Power Tools will, within the guarantee period, and from the original date of purchase, repair or replace any goods found to be defective in materials or workmanship. This guarantee is void if the tool being returned has been used beyond the recommendations in the Instruction Manual or if the machine has been damaged by accident, neglect, or improper service. This guarantee does not apply to machines and / or components which

have been altered, changed, or modified in any way, or subjected to use beyond recommended capacities and specifications. Electrical components are subject to respective manufacturers' warranties. All goods returned defective shall be returned prepaid freight to Evolution Power Tools. Evolution Power Tools reserves the right to optionally repair or replace it with the same or equivalent item. There is no warranty – written or verbal – for consumable accessories such as (following list not exhaustive) blades, cutters, drills, chisels or paddles etc. In no event shall Evolution Power Tools be liable for loss or damage resulting directly or indirectly from the use of our merchandise or from any other cause. Evolution Power Tools is not liable for any costs incurred on such goods or consequential damages. No officer, employee or agent of Evolution Power Tools is authorized to make oral representations of fitness or to waive any of the foregoing terms of sale and none shall be binding on Evolution Power Tools.

Questions relating to this limited guarantee should be directed to the company's head office, or call the appropriate Helpline number.

POWER TOOL GENERAL SAFETY INSTRUCTIONS

(These General Power Tool Safety Instructions are as specified in BS EN 60745-1:2009 & EN 61029-1:2009)



WARNING: Read all safety warnings and instructions.

Failure to follow the warnings and instructions may result in electric shock, fire and/or serious injury.

Save all warnings and instructions for future reference.

The term "power tool" in the warnings refers to your mains-operated (corded) power tool or battery-operated (cordless) power tool.

1) General Power Tool Safety Warnings [Work area safety]

- a) Keep work area clean and well lit.** Cluttered or dark areas invite accidents.
- b) Do not operate power tools in explosive atmospheres, such as in the presence of flammable liquids, gasses or dust.** Power tools create sparks which may ignite the dust or fumes.
- c) Keep children and bystanders away while operating power tool.** Distractions can cause you to lose control.

2) General Power Tool Safety Warnings [Electrical Safety]

- a) Power tool plugs must match the outlet. Never modify the plug in any way. Do not use any adapter plugs with earthed (grounded) power tools.** Unmodified plugs and matching outlets will reduce the risk of electric shock.
- b) Avoid body contact with earthed or grounded surfaces, such as pipes, radiators, ranges and refrigerators.** There is an increased risk of electric shock if your body is earthed or grounded.
- c) Do not expose power tools to rain or wet conditions.** Water entering a power tool will increase the risk of electric shock.
- d) Do not abuse the cord. Never use the cord for carrying, pulling or unplugging the power tool. Keep cord away from heat, oil, sharp edges or moving parts.** Damaged or entangled cords increase the risk of electric shock.
- e) When operating a power tool outdoors, use an extension cord suitable for outdoor use.** Use of a cord suitable for outdoor use reduces the risk of electric shock.
- f) If operating a power tool in a damp location is unavoidable, use a residual current device (RCD) protected supply.** Use of an RCD reduces the risk of electric shock.

3) General Power Tool Safety Warnings [Personal Safety].

- a) Stay alert, watch what you are doing and use common sense when operating a power tool. Do not use a power tool while you are tired or under the influence of drugs, alcohol or medication.** A moment of

inattention while operating power tools may result in serious personal injury.

b) Use personal protective equipment. Always wear eye protection. Protective equipment such as dust masks, non-skid safety shoes, hard hat or hearing protection used for appropriate conditions will reduce personal injuries.

c) Prevent unintentional starting. Ensure the switch is in the off-position before connecting to power source and or battery pack, picking up or carrying the tool.

Carrying power tools with your finger on the switch or energising the power tools that have the switch on invites accidents.

d) Remove any adjusting key or wrench before turning the power tool on. A wrench or key left attached to a rotating part of a power tool may result in personal injury .

e) Do not overreach. Keep proper footing and balance at all times. This enables better control of the power tool in unexpected situations.

f) Dress properly. Do not wear loose clothing or jewellery. Keep your hair, clothing and gloves away from moving parts. Loose clothes, jewellery or long hair can be caught in moving parts.

g) If devices are provided for the connection of dust extraction and collection facilities, ensure that these are connected and properly used. Use of dust collection can reduce dust-related hazards.

4) General Power Tool Safety Warnings [Power tool use and care].

a) Do not force the power tool. Use the correct power tool for your application.

The correct power tool will do the job better and safer at a rate for which it was designed.

b) Do not use the power tool if the switch does not turn it on or off. Any power tool that cannot be controlled with the switch is dangerous and must be repaired.

c) Disconnect the power tool from the power source and/or battery pack from the power tool before making any adjustments, changing accessories, or storing power tools. Such preventative safety measures reduce the risk of starting the power tool accidentally.

d) Store idle power tools out of the reach of children and do not allow persons unfamiliar with the power tool or these Instructions to operate the power tool.

Power tools are dangerous in the hands of untrained users.

e) Maintain power tools. Check for misalignment or binding of moving parts, breakage of moving parts and any other condition that may affect the power tools operation. If damaged, have the power tool repaired before use. Many accidents are caused by poorly maintained power tools.

f) Keep cutting tools sharp and clean. Properly maintained cutting tools with sharp cutting edges are less likely to bind and are easier to control.

g) Use the power tool, accessories and tool bits etc. in accordance with these instructions, taking into account the working conditions and the work to be performed. Use of the power tool for operations different from those intended could result in a hazardous situation.

5) General Power Tool Safety Warnings [Service]

a) Have your power tool serviced by a qualified repair person using only identical replacement parts. This will ensure that the safety of the power tool is maintained.

SAFETY INSTRUCTIONS FOR HULK-SYSTEM PETROL ENGINE

a. Petrol or diesel powered engines must never be used in unventilated closed spaces. The exhaust fumes produced are highly toxic and can cause 'Carbon Monoxide Poisoning' which will cause drowsiness and ultimately death. It is only permissible to run a petrol engine indoors if the building can be very well ventilated and the exhaust fumes can be captured and ducted to the outside through an exhaust extraction/scavenger system.

b. The engine should not be run at speeds that exceed the maximum speed on the rating plate. Operating an engine at excessive speeds increases the likelihood of component failure and consequent accidents.

c. Do not tamper with components that

regulate the engines speed. You may alter the factory set running parameters.

d. Use only the type of fuel listed in this Instruction Manual. Using fuel with an octane rating less than that specified can lead to excessive engine wear and premature engine failure.

e. Keep the area around the engine clear, clean and tidy. Never allow any combustible material (timber, plastic, cardboard, canvas etc) near a running engine.

f. Do not use in or near to potentially explosive atmospheres. Dust laden atmospheres as can be found in some industrial buildings (Flour Mills, Timber Mills) have an explosive potential.

g. Regularly check the fuel system for leaks. Hoses and unions should be checked for deterioration or chafing. Check the fuel tank for damage or for a poorly fitting or worn fuel cap. Any defects must be rectified before the engine is used.

h. Always stop the engine and allow it to cool down before refuelling. Try to avoid any fuel spillage (often caused by 'overfilling' the tank) and clean up any spilt fuel immediately. The application of dry sand is an effective way of neutralising fuel spills. Do not allow sand to come into contact with any part of the engine.

i. When transporting the engine in a vehicle ensure that the fuel tap is turned off. To minimise the risk of fuel spillage the engine should be secured by ropes etc to the load area of the vehicle so that it cannot move during transportation. The engine should be secured in as level an attitude as possible.

j. For long term storage we recommend that the fuel system of the engine is drained. During long term storage additives in modern fuels can precipitate from the fuel and block jets and valves in the fuel system.

k. Store the machine in a secure and well ventilated area. Unauthorised personnel should not have access to this machine.

SAFETY INSTRUCTIONS FOR FUEL FILLING

a. Select level bare ground, remote from any buildings as a refuelling station. Ensure that there is no combustible material in the immediate vicinity.

b. Smoking, using a naked flame or producing sparks is strictly forbidden whilst refuelling. Petrol is highly flammable and its vapours are combustible.

c. Ensure that the fuel tap is turned 'off'. This will ensure that fresh fuel does not 'flood' the engines carburettor.

d. The engine must be turned 'off' and allowed to cool before refuelling is attempted. Inadvertent fuel spillage onto a hot engine can result in the risk of fire.

e. Any fuel spills must be dealt with immediately. If petrol contaminates any clothing the operator must change clothes. Do not rely on the fuel evaporating from the clothes. Wash or launder the clothing when the fuel has evaporated from the material.

f. The use of a funnel during refuelling is recommended. Use of a funnel will minimise the risk of fuel spillage.

g. Fill the tank with the correct grade of unleaded fuel to a level approximately half way up the fuel filter. Pour the fuel into the tank carefully and do not try to fill the tank completely. Pour the petrol slowly to avoid air traps during filling that could cause fuel spillage.

h. Check the fuel tank cap, and replace as soon as refuelling is completed. The cap has a bayonet type connection. Check that it is correctly installed and seated before slowly turning on the fuel tap.

i. Check for any fuel leaks throughout the fuel system. Do not attempt to start the engine if a fuel leak is suspected. Any detected leak must be repaired by a suitably qualified technician.

j. Observe all national and/or local regulations about the storage and use of petroleum products. All local bye laws should be observed.

HEALTH ADVICE

 **WARNING:** When using this machine, dust particles will be produced. In some instances, depending on the materials you are working with, this dust can be particularly harmful. You are advised to consider the risks associated with the materials you are working with and to reduce the risk of exposure. As some materials can produce dust that may be hazardous to your health, we recommend the

use of an approved face mask with replaceable filters when using this machine.

You should always:

- Work in a well-ventilated area.
- Work with approved safety equipment, such as dust masks that are specially designed to filter microscopic particles.

 **WARNING:** the operation of any power tool can result in foreign objects being thrown towards your eyes, which could result in severe eye damage. Before beginning power tool operation, always wear safety goggles or safety glasses with side shield or a full face shield where needed.

 **WARNING:** If any parts are missing, do not operate your machine until the missing parts are replaced. Failure to follow this rule could result in serious personal injury.

ADDITIONAL SAFETY RULES FOR HULK COMPACTOR

a. Cordon off the work area. Members of the public and unauthorised personnel should be kept at a safe distance from compacting operations.

b. Be completely sure that you know how to switch the machine 'off'. If you get into difficulty during compacting operations it is important that you can perform an emergency shutdown of the machine.

c. Never leave the Hulk running and unattended. The machine vibrates as soon as it is started, and will also begin to move forwards. The machine must be shutdown if it is left unattended.

d. Always switch the engine 'off' before moving the machine around the site. When moving or transporting the machine the engine must be switched 'off' and preferable cold, with the fuel tap in the 'off' position.

e. As the Hulk engine becomes hot during use ensure that you do not touch the engine or allow any combustible material or clothing to contact the engine during use. Only touch or service a cold engine.

f. Never remove, alter or tamper with any of the machines guards. The guards are specially designed and fitted to provide you with the

greatest possible protection during operations. If a guard is missing or damaged do not use the machine until the guard is repaired or replaced by a competent technician.

g. Be especially careful to maintain control when working on a sloping surface. Work up and down a sloping surface not across it.

h. Where there are a number of different layers to be compacted on top of each other, compact each layer separately. This will ensure the integrity of each layer.

i. Work the Hulk over the work surface in an organised pattern until the desired compaction is achieved. This ensures the safest working practice is maintained.

j. Always carry out the pre-use safety checks before starting operations. Follow the guidance in later sections of this Manual.

PPE (Personal Protective Equipment)

Note: If using this equipment on a construction site it is important that the operator conforms to any site rules/regulations that may apply. Consult the site foreman or other responsible person for details.

a. Wear suitable clothing. This could include a Boiler Suit or Padded Coverall and Hi Vis jacket etc.

b. Wear suitable footwear. Safety shoes with steel toe caps and anti-slip soles are recommended.

c. Wear suitable Safety Glasses. A Full Face Safety Shield or Safety Goggles with side shields which provide protection from thrown debris is recommended.

d. Protect you hearing. Wear suitable ear protectors.

e. Wear suitable gloves. High grip gloves are recommended.

f. Wear respiratory protection. A dust mask with replaceable filters which provide protection against fine toxic dust, fibres and vapours is recommended.

g. Wear a Safety Helmet. The use of a Safety Hat may be compulsory on construction sites to protect the operator from potential overhead dangers.

VEHICULAR TRANSPORTATION



WARNING: This machine requires at least a two man lift.

Prepare the vehicle in advance so that it is ready to receive the machine. **Take great care to ensure that the machine is not dropped during loading/unloading.**

- Although compact, this machine is heavy. To reduce the risk of injury, get competent help whenever you have to lift this machine.
- To reduce the risk of back injury, hold the machine close to your body when lifting. Bend your knees so you can lift with your legs, not your back. Lift by using convenient areas of the main external frame.
- Lift the machine into the vehicle and secure in as level an attitude as possible with ropes, tie down straps etc so that the machine cannot move during transportation.

Note: Hulk Petrol: It is best and safest practice when transporting this machine in a vehicle that there should be no fuel present in the machine's fuel tank.

INTENDED USE OF THIS POWER TOOL



WARNING: This product is a powered Compaction Plate and has been designed to be used with special **Evolution** accessories. Only use accessories designed for use with this machine and/or those recommended specifically by **Evolution Power Tools Ltd.**

This machine can be used to compact surfaces such as crusher run, small aggregates, soil, sand and sub base materials etc. When fitted with the Paving Pad, the Hulk can be used to compact and settle most types of block paving.

Reasons for Compaction

Disturbed soil, new infill, subbase or blacktop will have air pockets and small voids within, which, if not compacted can lead to possible problems developing.

- As traffic crosses the surface of an uncompacted area, the loads imposed press downwards on the material underneath. This can lead to subsidence of the top surface as material migrates downwards to fill the voids.
- A static load (house, garage etc) built upon uncompacted ground could suffer subsidence as material beneath it moves.
- Water seeping into material that contains voids and air pockets can collect in these spaces and will expand during freezing conditions and contract again during warm/dry spells. Expansion and contraction is a major contributory factor causing damage to building foundations, and can lead to a structure needing underpinning.

Compaction increases the density of the material and hence its ability to withstand static and dynamic loads. Eliminating air pockets and small voids reduces the chances of water ingress collection and subsequent subsidence due to material expansion and contraction.

PROHIBITED USE OF THIS POWER TOOL



WARNING: This product is a powered Compaction Plate and must only be used as such. It must not be modified in any way, or used to power any other equipment or drive any other accessories other than those mentioned in this Instruction Manual.



WARNING: This machine is not intended for use by persons (including children) with reduced physical, sensory or mental capabilities, or lack of experience and knowledge, unless they have been given supervision or instruction concerning the safe use of the machine by a person responsible for their safety. Children should be supervised to ensure that they do not have access to, and are not allowed to play with, this machine.

ELECTRICAL SAFETY – HULK ELECTRO

THE MAINS PLUG

This product is fitted with the correct moulded plug for the designated sales market. The plug meets the requirements of international standards, and must be connected to a supply voltage that is equal to that stated on the rating label. If the plug or mains supply lead are damaged they must be replaced with a complete assembly that is identical to the original. Adhere to the requirements for mains electricity supply connection that applies in your Country. If in doubt consult a qualified electrician.

BS plug can only be used in the UK. The plug should be plugged into the socket indoor to fulfil the required IP protection degree. The plug should be incorporated with a power cord longer than 10m.

OUTDOOR USE – HULK ELECTRO



WARNING: For your protection if this tool is to be used outdoors it should not be exposed to rain, or used in very damp locations. For added protection use a residual current device (R.C.D.) that will interrupt the supply if the leakage current to earth exceeds 30mA for 30ms. Always check the operation of the residual current device (R.C.D.) before using the machine.

If an extension cable is required it must be a suitable type for use outdoors and so labelled.

The manufacturers instructions should be followed when using an extension cable.

VIBRATION

⚠ WARNING: When using this machine the operator can be exposed to high levels of vibration transmitted to the hand and arm. It is possible that the operator could develop “Vibration white finger disease” (Raynaud syndrome). This condition can reduce the sensitivity of the hand to temperature as well as producing general numbness. Prolonged or regular users of compacting machines should monitor the condition of their hands and fingers closely. If any of the symptoms become evident, seek immediate medical advice.

- The measurement and assessment of human exposure to hand-transmitted vibration in the workplace is given in: BS EN ISO 5349-1:2001 and BS EN ISO 5349-2:2002
- Many factors can influence the actual vibration level during operation e.g. the work surfaces condition and orientation and the type and condition of the machine being used. Before each use, such factors should be assessed, and where possible appropriate working practices adopted. Managing these factors can help reduce the effects of vibration:

Handling

- Handle the machine with care, allowing the machine to do the work.
- Avoid using excessive physical effort on any of the machines controls.
- Consider your security and stability, and the orientation of the machine during use.









Work Surface

- Consider the work surface material; its condition, density, strength, rigidity and orientation.

SYMBOLS AND LABELS

⚠ WARNING: Do not operate machine if warning and/or instruction labels are missing or damaged. Contact Evolution Power Tools for replacement labels.

Note: All or some of the following symbols may appear in the manual or on the product.

Read the Manual	
Wear Ear Protection	
Wear Eye Protection	
Wear Dust Protection	
Warning	
CAUTION: Hot exhaust Do not touch	
CAUTION: This is a 4 stroke engine. Fill with petrol only. Do not fill with diesel oil.	
Allow motor to cool before opening the fuel cap. The vapour is extremely flammable and may ignite on contact with a hot surface or flames.	

MACHINE OVERVIEW HULK PETROL

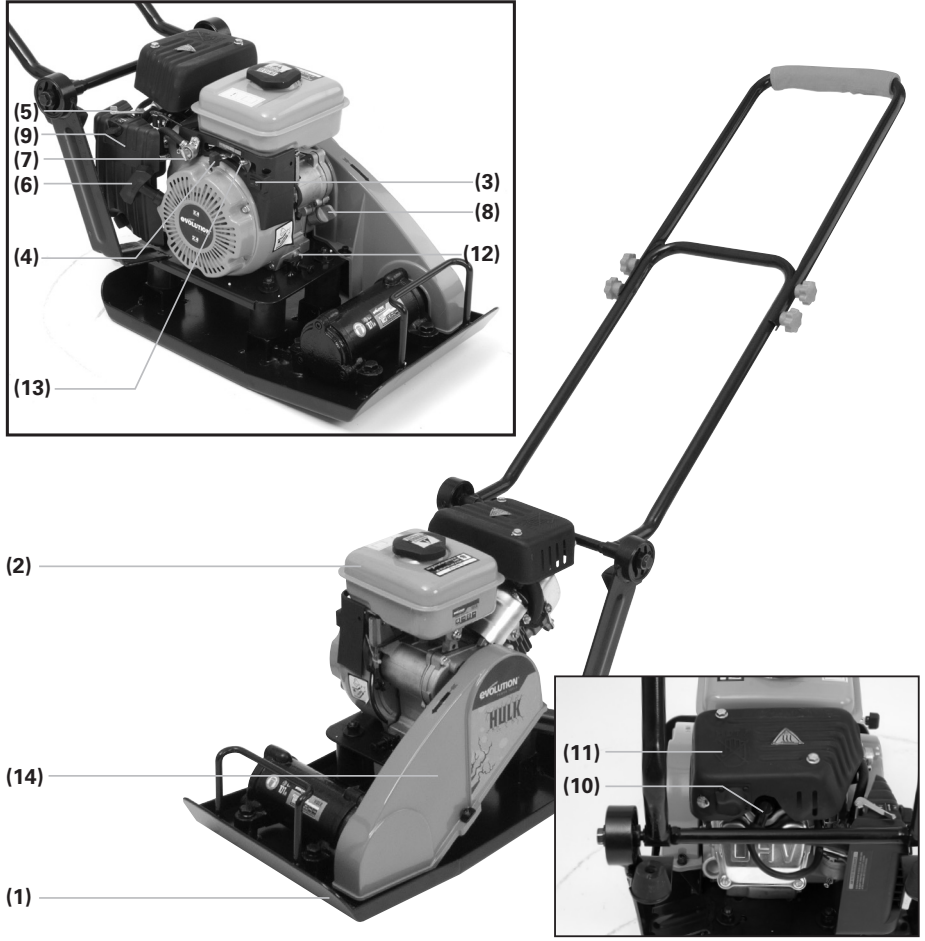

- | | |
|------------------------------------|-------------------------------|
| 1. VIBRATION PLATE | 8. ENGINE OIL FILLER/DIPSTICK |
| 2. FUEL TANK | 9. AIR FILTER |
| 3. ENGINE 'ON/OFF' IGNITION SWITCH | 10. SPARK PLUG |
| 4. THROTTLE LEVER | 11. EXHAUST |
| 5. CHOKE CONTROL | 12. ENGINE OIL DRAIN PLUG |
| 6. RECOIL STARTER | 13. FAST RUN ADJUSTMENT SCREW |
| 7. FUEL TAP | 14. BELT GUARD |

MACHINE OVERVIEW HULK ELECTRO



1. VIBRATION PLATE

2. CROSSBAR/CABLE STORE

3. SAFETY START 'ON/OFF' SWITCH

4. ANTI-VIBRATION HAND GRIP

5. UPPER SECTION - HANDLE

6. MIDDLE SECTION - HANDLE

GETTING STARTED

UNPACKING

Caution: This packaging contains sharp objects. Take care when unpacking. This machine could require two persons to lift, assemble and move this machine. Remove the machine, together with the accessories supplied from the packaging. Check carefully to ensure that the machine is in good condition and account for all the accessories listed in this manual. Also make sure that all the accessories are complete. If any parts are found to be missing, the machine and its accessories should be returned together in their original packaging to the retailer. Do not throw the packaging away; keep it safe throughout the guarantee period. Dispose of the packaging in an environmentally responsible manner. Recycle if possible. Do not let children play with empty plastic bags due to the risk of suffocation.

ITEMS SUPPLIED - HULK PETROL COMPACTOR

DESCRIPTION	QUANTITY
Instruction Manual	1
Handle Extension	1
Handle Extension attachment thumb screws	4
Spark Plug Box Spanner	1
Engine Oil (500 ml bottle)	1

ITEMS SUPPLIED - HULK ELECTRO COMPACTOR

DESCRIPTION	QUANTITY
Instruction Manual	1
Handle attachment thumb screws (long)	2
Handle attachment thumb screws (short)	2
Handle cross bar/cable store	1

Additional Accessories

In addition to the standard items supplied with this machine the following accessories are also available from the Evolution online shop at www.evolutionpowertools.com or from your local retailer.

DESCRIPTION	PART No
Hulk Paving Pad	Hulk Pad

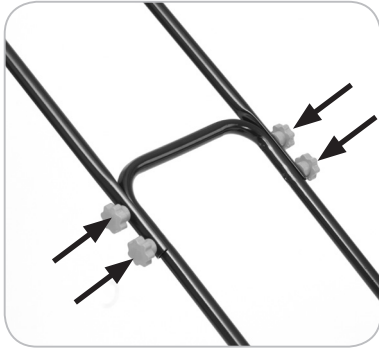

Fig. 1

ASSEMBLY

Your Evolution Hulk needs some minor assembly and some minor operator adjustments to prepare the machine for use. If you have the petrol engine machine complete all assembly before filling the engine with 0.25L of the recommended service oil.

1. Attaching the Extension Handle – Hulk Petrol

Note: The Handle Extension has an anti-vibration hand grip which helps the operator to manage the vibration transmitted by the machine to the hand/arm of the operator. The Extension Handle should be fitted for operational purposes, but can be removed, if convenient, during transportation or storage. Removing the bottom two thumb screws and loosening the top two thumb screws allows the handle extension to be folded forwards for ease of transportation.

- Carefully slide the Extension Handle over the main operating handle and align the four (4) holes in the Extension Handle with the four (4) captive nuts in the main handle.
- Insert the four (4) $\varnothing 10$ mm thumb screws through the Extension Handle holes and into the captive nuts. (**Fig. 1**)
- Tighten all four (4) thumb screws securely.

2. Assembling/attaching the Handle – Hulk Electro

Note: The Hulk Electro Handle consists of four (4) main parts:

- Lower handle (pivoting and factory attached to the machine).
- Middle section.
- Upper section with 'On/Off' safety switch.
- Cross-bar/cable store.

The two long thumb screws are used to attach the cross-bar/cable store and the middle section of the handle to the pivoting lower handles.

- Carefully position the cross-bar cable store into its service position.

Note: The cable pins should face rearwards.

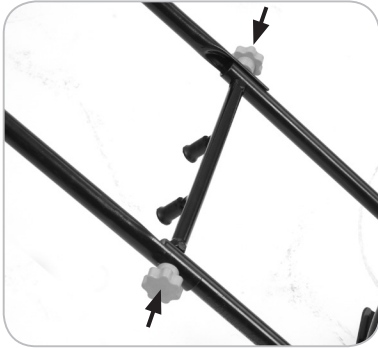

Fig. 2

- Carefully slide the Middle Section over the lower handles and align the holes.
- Insert the long thumb screws through the holes in the middle handle, through the holes in the lower handles and screw them into the captive nuts in the cross-bar/cable store. **(Fig. 2)**
- Tighten these screws securely.

The two (2) short thumb screws are used to attach the Upper Section of the handle to the Middle Section.

- Carefully slide the Upper Section of the handle over the Middle Section and align the holes.
- Insert the thumb screws through the Upper Section handle and screw them into the captive nuts within the Middle Section.



Fig. 3

WARNING: Take care to ensure that the power cable from the Safety Switch down to the motor is 'free' and not 'trapped' during the assembly process.

Initial filling and checking the oil level – Hulk Petrol

WARNING: This machine does not come filled with oil. No attempt to start the engine must be made until the crankcase is filled to the correct level with the correct grade of oil.

Note: Oil (provided) should be poured into the machine through the Oil Filler/Level Cap. Oil capacity is approximately 0.25 litre of 10W 30 automotive oil (available at all good motor factors and most petrol stations). For some non-temperate climatic areas an alternative grade of oil may be preferable – consult your supplier.

The Oil Filler Cap unscrews from the machines engine casing and incorporates an oil level dip stick. **(Fig. 3)** Take care not to spill any oil.

Note: It is important that when checking the oil level the machine is on a stable, horizontal and level surface with the engine stopped and cold.

Two index marks are provided on the dipstick. The oil level should be maintained at or near the upper index mark.



Fig. 4

- Remove the Oil Filler/Level Cap and wipe the dipstick with a clean dry cloth.
- Pour in the required amount of oil. (approx 0.25L)
- Allow the oil to settle for 10+ seconds.
- View the oil level through the oil filler orifice. The oil level should be very near the top of the threads with oil just about to spill out from the crankcase (the machine must be on a level horizontal surface).
- Insert the dipstick and screw the cap fully 'home'. Unscrew the filler cap and withdraw the dipstick. Visually check the oil level on the dipstick.
- Adjust as necessary.
- When the level is correct tighten the Oil Filler/Level Cap securely into the engine casing.



Fig. 5

Note: Change the oil according to the Maintenance Summary Chart (Refer also to MAINTENANCE – Engine oil replacement)

Pre – operating checks

Note: Before each operation the machine should be inspected to ensure that all safety features etc, are working correctly.

- Check that all safety guards are in position and undamaged.
- Hulk Electro – Check the integrity of the power cable and plug. If the power cable or plug is damaged in any way the cable and/or the plug must be replaced by a competent technician with identical replacement parts.
- Hulk Petrol - Check all fuel hoses, unions and filler caps etc for signs of fluid leakage. Any leak detected must be repaired before operations commence.
- Check the engine oil level and adjust as necessary.
- Check the fuel level and top up as necessary.
- Thoroughly inspect the rest of the machine for any form of damage particularly to covers, guards, rubber components etc.

Starting the Hulk Engine

- Turn the fuel tap lever to the 'On' position. **(Fig. 4)**
- Set the choke lever to the 'Choke On' position. **(Fig. 5)**



Fig. 6

- Press the engine ignition rocker switch to the 'ON' (I) position. **(Fig. 6)**
- Set the throttle lever to maximum. **(Fig.7)**

Note: The throttle can normally be left in this position at all times.

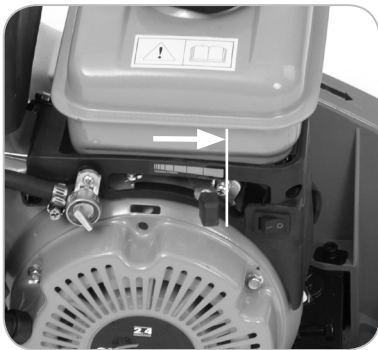

Fig. 7

- Steady the Hulk by holding the operating handle at a convenient point.
- Use your other hand to grip the recoil starter cord handle. **(Fig. 8)**
- Pull the recoil starter cord slowly until resistance is felt indicating that the starter is engaged.
- When resistance is felt pull the cord sharply.
- Continue this procedure until the engine starts.
- Allow the engine to achieve operating temperature.
- Usually the choke can be returned to the 'off' (run) position almost immediately when the engine fires up, but this will depend upon ambient temperatures, operating conditions etc. and operator discretion will be required.
- Under some circumstances choke may be needed even when the engine is warm from a previous operating cycle. If you experience difficulty in starting a warm engine:

- Set the choke to the 'on' position.
- Pull the recoil starter once.
- Return the choke to the 'off' (run) position.
- Pull the recoil starter until the engine fires.

- **Note:** The Hulk will begin to vibrate and travel as soon as the engine is started. The operator should ensure due diligence when starting this machine.

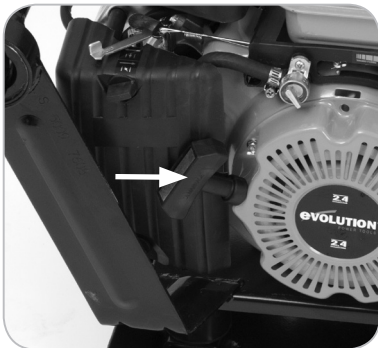

Fig. 8

Stopping your Hulk Petrol Engine

- Press the engine ignition rocker switch to the 'OFF' (0) position.
- Close the fuel tap.



Fig. 9



Fig. 10

Machine Travel – Hulk Petrol

Note: Adjusting the speed of the engine alters the frequency of vibration and also the speed at which the machine travels forwards. Adjusting the engine speed controls should only be attempted with the engine switched off and not running.

Note: The Fast Run Screw limits the maximum travel of the throttle lever and thus controls maximum engine speed only.

If you need to alter the maximum engine speed to increase or decrease the speed of 'travel' of the machine:

- Turn the Fast Run Screw (**Fig. 9**) a little at a time (half a turn max) clockwise to decrease the engine speed, or counter clockwise to increase the speed of the engine.
- Ensure that the throttle is set to maximum.
- Start the machine and check the 'travel' of the machine at the new Fast Run Screw setting.
- If necessary stop the machine and adjust further the Fast Run Screw until the desired 'travel' speed is achieved.

Starting and Stopping the Hulk Electro

The Hulk Electro is fitted with a Safety Start 'On/Off' switch. The safety interlock prevents the switch lever from being operated until the safety lock button is depressed.

- Press the safety lock button (**Fig. 10**) and pull the switch lever to start the machine.
- Release the switch lever to switch off the machine.

Note: Upon release of the switch lever the motor will stop and the safety lock button will automatically revert to 'safe mode'.

WARNING: The operator should always be aware of the routing of the power cable to ensure that it does not become a 'trip' or any other form of hazard, or could be 'run over' by the machine.

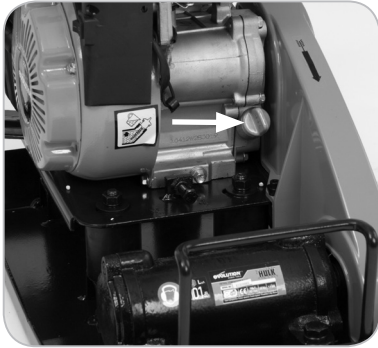

Fig. 11

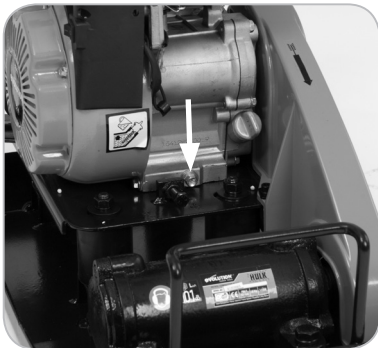

Fig. 12

GENERAL OPERATING ADVICE

- Ensure that bystanders are kept at a safe distance from compacting operations. If necessary cordon off the work area and post **WARNING** notices.
- Plan your work, and the path you intend the machine to travel, before you start compacting operations.
- Survey the working area before you begin and remove or otherwise neutralise any obstructions/obstacles that could pose a danger.
- Ensure you have all the correct PPE and know how to use it.
- The compactor will travel forwards under its own power. Gentle inputs from the operator on the machines handle are all that is necessary to 'steer' the machine. The operator should hold the anti-vibration handle grip with both hands, and the hands should be positioned as far apart as possible.
- Several passes over the work area may be required to compact the material to the desired density.
- If the work area is sloped, work up and down the sloping surface, not across

MAINTENANCE

HULK PETROL

Regular maintenance is essential to keep your machine and its accessories in serviceable condition. We recommend that only competent operators who have experience in servicing and maintaining petrol engines attempt these procedures. If in doubt have the machine serviced at an Evolution approved Service Centre.

1. Engine oil replacement

Engine oil should be replaced after the initial 'running in' period and at the intervals specified in the Service Schedule.

Note: Engine oil is easier to replace when the engine has been run up to temperature and the oil is warm.

- Ensure that the engine is positioned on a hard level surface.
- Remove the oil filler cap. (**Fig. 11**)
- Place a suitable oil collection pan under the engine.
- Remove the oil drain plug so that the oil can drain completely from the engine. (**Fig. 12**)



Fig. 13

WARNING: Be careful. Contact with used engine oil can be harmful. The oil could be very hot (burn risk) and some operators may experience irritation if the oil contaminates exposed skin. The operator should consider wearing mechanics protective gloves if available. Any skin contaminated with oil should be washed with soap and copious amounts of clean water as soon as possible.

- Check the oil drain plug and its gasket.
- Check the oil filler cap and its 'O' ring gasket.
- Replace any non-serviceable parts.
- Re-install the oil drain plug and tighten firmly.
- Refill the engine with the correct grade of engine oil to the correct level.
- Refit the oil filler cap.
- Check for leaks and spillages, and deal with as necessary.

Note: Used engine oil should be disposed of in an environmentally safe way. Check with your Local Authority for the nearest used oil re-cycling facility.

2. Spark Plug - Checking and replacement

After approximately 50 hours of operation the spark plug should be removed for checking, cleaning and resetting.

To remove and reinstall the spark plug:

- Ensure that the engine is switched 'OFF' and the fuel tap is in the 'OFF' position.

WARNING: The engine should be cold before commencing the spark plug removal procedure.

- Pull the HT lead from the spark plug.
- Using a spark plug socket (supplied) remove the spark plug. (**Fig. 13**)

A serviceable spark plug in good condition should exhibit light tan deposits on the plug nose. Remove these deposits with a stiff brass wire brush.

- Check the electrode gap of the plug using a set of feeler gauges.
- Adjust if necessary. The gap is given in 'Specification Hulk Petrol'.
- Re-install the spark plug. Be careful that it engages the threads in the cylinder head correctly.

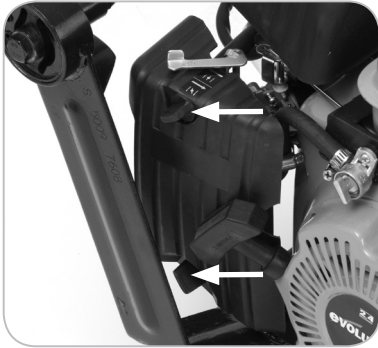

Fig. 14

- Hand-tighten the spark plug using the supplied spark plug socket.
- Slide a short, suitable tommy bar through the hole in the end of the spark plug socket.
- Position the tommy bar so that equal amounts protrude through either side of the spark plug socket.
- Finally make the gas tight seal by turning the spark plug socket between $\frac{1}{4}$ to $\frac{1}{2}$ of a turn. This final fractional turn will crush the spark plug washer and make a gas tight seal. Do not over-tighten the spark plug.
- Reattach the HT lead to top of the spark plug.

3. Air Filter

WARNING: Never run the engine without the air filter element fitted.

After approximately 50 hours of use the condition of the air filter should be checked.

Note: The air filter may require more frequent attention if the operating environment is especially dusty.



Fig. 15

To remove:

- Ensure that the engine is switched 'OFF' and the fuel tap is in the 'OFF' position. The engine should be cold.
- Unscrew the wing nuts from the Air Filter housing cover and remove it. **(Fig. 14)**
- Carefully store these parts for later re-installation.
- Remove the Air Filter Element from the housing for inspection. **(Fig. 15)** If the paper element of the air filter shows signs of severe discolouration and clogging by dirt, dust etc it should be replaced.

To refit:

- Install the element into the Air Filter Housing. A new element can fit either way round.
- Replace the Air Filter housing cover.
- Replace the wing nuts and ensure that the cover is correctly seated and the wing nuts are securely tightened.

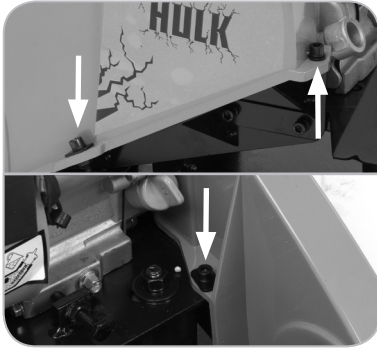

Fig. 16

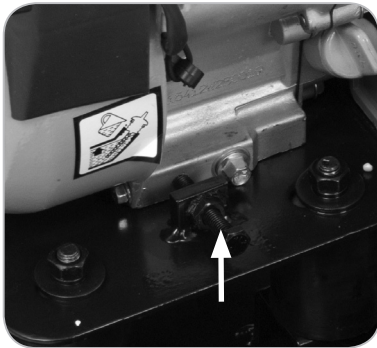

Fig. 17

4. Fuel Tank Filler Filter

Occasionally visually check the condition of the fuel tank filler filter (when refuelling is ideal). If there is any sign of deposit build up, remove the filter from the tank and clean.

- Clean the filter with environmentally friendly water based degreasing agent and if necessary blow the fine mesh through with clean, dry compressed air.
- Allow to dry thoroughly before refitting.
- When refitting, ensure that the 2 cut outs on the top edge of the filter line up with the cut outs in the fuel tank filler neck.

5. Checking the Drive Belt Tension

WARNING: Only attempt this procedure with the machine cold and the engine switched 'off' and the spark plug cap removed.

Drive belt tension should be checked after the first 4 hours of use and then as specified in the Routine Maintenance Schedule.

To check the Drive Belt Tension:

- Remove the Belt Guard by removing the three (3) socket headed screws (**Fig. 16**) using a hex key and spanner (not supplied) and store safely for future use.

Note: These three (3) socket headed screws are position specific. Note the position of each of the screws and its related accessories as it is removed from the machine so that it can be replaced in its original position.

- Deflection by light finger pressure at the mid-point of the belt should be approximately 5/6 mm (1/4 inch).

Note: The engine unit of the Hulk is positioned over four (4) slots on the Engine Mounting Plate. Four (4) engine mounting bolts are positioned through these four slots and are screwed from underneath up into the base of the engine crankcase block. This arrangement enables the engine to be repositioned on the plate.

- Loosen the four (4) hexagonal headed bolts using a suitable spanner (not supplied).
- Slide the engine backwards or forwards to alter the tension of the Drive Belt. An adjustment screw (**Fig. 17**) is provided at the front of the engine to aid precise positioning of the engine.
- When correct tension has been achieved, securely tighten the engine mounting bolts.

 **WARNING:** Do not adjust the adjustment/tensioning bolt without loosening the four mounting bolts, as this could cause damage to the engine casing.

Note: Care must be taken to ensure that the engine remains 'square' and 'inline' on the mounting plate. If the engine were to be in a slightly 'twisted' configuration on the mounting plate, the drive belt and pulleys would be put under 'distress' and wear quickly ensue.

- Replace the drive Belt Guard and securely tighten the three (3) socket headed screws in their original positions.

6. Recoil Starting System

The ventilation slots should be kept clean and free from any obstructions.

Remove any foreign matter from the ventilation slots.

HULK PETROL

ROUTINE MAINTENANCE SCHEDULE	After first 4 hours	Every 20 hours or monthly	Every 50 hours or 3 monthly	Every 100 hours or 6 monthly
Engine Oil Level Check	●	●		
Engine Oil Change		● (1 st change only)		●
Air Filter Check		●		
Air Filter Replace				●
Spark Plug Check				●
Drive Belt Tension	●	●		
Fuel Filter Check/Clean			●	

MAINTENANCE HULK ELECTRO

Note: Any maintenance must be carried out with the machine switched off and disconnected from the power supply.

Check that all safety features and guards are operating correctly on a regular basis. Only use this machine if all guards/safety features are fully operational.

All motor bearings in this machine are lubricated for life. No further lubrication is required.

Use a clean, slightly damp cloth to clean the plastic parts of the machine. Do not use solvents or similar products which could damage the plastic parts.

 **WARNING:** Do not attempt to clean by inserting pointed objects through openings in the machines casings etc. The machines air vents should be cleaned using compressed dry air.

TROUBLESHOOTING HULK PETROL

PROBLEM	CAUSE	POSSIBLE REMEDY
Engine will not start.	<p>No Fuel.</p> <p>Engine switched 'Off'.</p> <p>Fouled spark plug.</p> <p>Engine cold.</p> <p>Engine 'flooded' with petrol.</p> <p>Air Filter clogged or contaminated with oil.</p> <p>Major Fault.</p>	<p>Open Fuel Tap</p> <p>Fill Fuel Tank.</p> <p>Switch Engine 'On'.</p> <p>Remove, clean, reset and replace plug.</p> <p>Ensure choke setting is correct.</p> <p>Leave for five (5) mins.</p> <p>Open choke and fully open the throttle and try again.</p> <p>Remove spark plug, clean and replace.</p> <p>Try again until engine fires.</p> <p>Replace Air Filter.</p> <p>Contact Agent or Evolution Power Tools for further advice.</p>
Machine does not vibrate.	<p>Belt Tension Incorrect.</p> <p>Air Filter Blocked.</p> <p>Eccentric Unit Damaged.</p> <p>Engine speed too slow.</p>	<p>Adjust the belt tension.</p> <p>Renew the Air Filter.</p> <p>Replace eccentric unit.</p> <p>Increase engine speed slightly.</p>

TRUBLE SHOOTING HULK ELECTRO

PROBLEM	CAUSE	POSSIBLE REMEDY
Machine will not start.	<p>Supply not switched 'On'</p> <p>Fuse in Plug 'blown'.</p> <p>Safety Start Button not depressed preventing 'On/Off' actuation.</p> <p>Damaged or broken power cord.</p>	<p>Switch on supply at the socket.</p> <p>Replace fuse and check supply.</p> <p>Depress Safety Start Button and then pull Start Lever.</p> <p>Have the damaged cord replaced by an identical type fitted by a competent technician.</p>

GENERAL TROUBLESHOOTING GUIDE

PROBLEM	CAUSE	POSSIBLE REMEDY
Paving blocks damaged.	Plate in direct contact with the pavings.	Fit a 'Hulk Paving Pad'.
Bituminous surface flaking (laminating).	Over compactation.	Remove and relay.
Low travel speed.	Layer thickness too deep (plate sinking). Engine speed too low. Moisture content of the material too high or too low.	Remove some of the material so that the layer thickness is reduced. Increase engine speed slightly. Remove the material and adjust the moisture content.
Petrol Hulk not Travelling.	Engine speed too low.	Increase engine speed slightly.



Fig. 18

LONG TERM STORAGE HULK PETROL

If your Evolution machine is not going to be used for a period of 4 months or more (e.g. over the winter period) the operator should consider preparing it for long term storage. This will keep the engine in optimum condition for re-commissioning when required.

- Drain all the fuel from the fuel tank and carburettor into a suitable approved container.
- A drain tap can be found underneath the carburettor float bowl. Loosen this tap to allow the fuel to drain from the machine. **(Fig. 18)**
- Tighten the drain tap when all the fuel has been removed.
- Remove the spark plug.
- Pour approximately one tablespoon of clean engine oil into the spark plug hole.
- Ensure that the engine ignition switch is in the 'OFF' position.
- Gently pull the recoil starter a few times.
- Replace the spark plug.
- Gently pull the recoil starter until resistance is felt (this will mean that the piston is on its compression stroke with both valves closed). Stop pulling the recoil starter.
- Store the engine in a secure, dry and well ventilated location, under a cover to prevent dust, debris etc from settling on the machine.

Use of Optional Evolution Accessories

(available as a customer purchase option)

Evolution Paving Pad

Using the Paving Pad allows the operator to compact/settle Driveway Paving, Block Paving and Patio Slabs etc without the risk of damage or scratching to the decorative top surface of the pavings by the steel vibration pad.

Note: The Paving Pad has a plate hook to the front, and a plate clamp to the rear.

To fit the Paving Pad:

- Hook the Paving Pads plate hook over the front of the vibration plate.
- Clamp the plate clamp over the rear of the vibration plate.

Note: You may find it helpful to remove the large 'inside' steel rear clamping plate from the plastic Paving Pad.

- Remove the two (2) 13mm AF bolts and locking nuts. Store safely for future use.
- Position the plastic Paving Pad on the vibration plate.
- Clamp the rear of the Paving Pad to the vibration plate using the large steel plate clamp and the two (2) 13mm AF bolts and locking nuts.
- Tighten the 13mm AF nuts and bolts securely.

ENVIRONMENTAL PROTECTION

Waste electrical products should not be disposed of with household waste. Please recycle where facilities exist. Check with your Local Authority or retailer for recycling advice.



HULK PETROL PARTS DIAGRAM

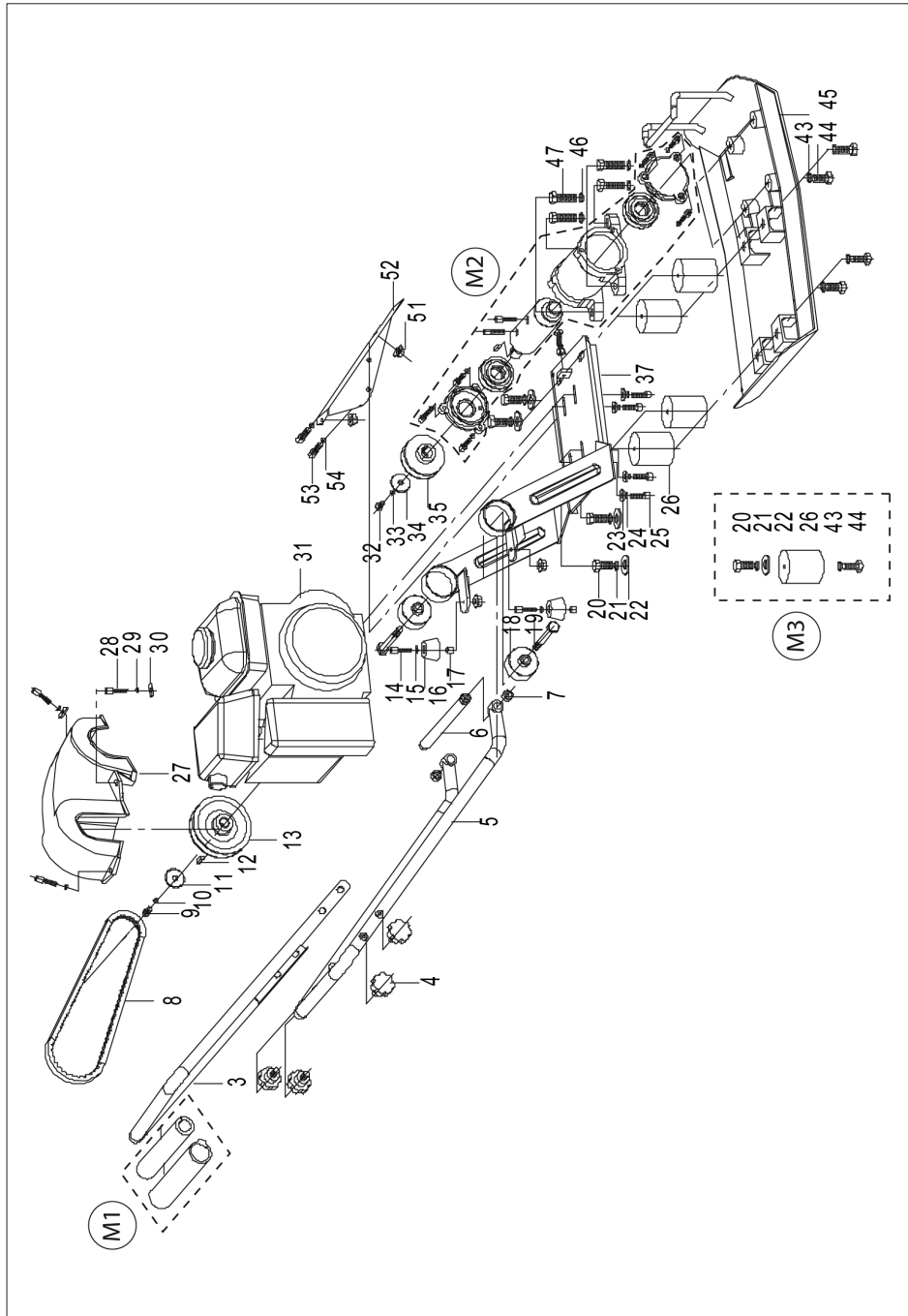

EC DECLARATION OF CONFORMITY

In accordance with EN ISO 17050-1:2004

HULK PETROL



The manufacturer of the product covered by this Declaration is:

UK: Evolution Power Tools Ltd. Venture One, Longacre Close, Holbrook Industrial Estate, Sheffield, S20 3FR.

FR: Evolution Power Tools SAS. 61 Avenue Lafontaine, 33560, Carbon-Blanc, Bordeaux, France.

The manufacturer hereby declares that the machine as detailed in this declaration fulfils all the relevant provisions of the Machinery Directive and other appropriate directives as detailed below. The manufacture further declares that the machine as detailed in this declaration, where applicable, fulfils the relevant provisions of the Essential Health and Safety requirements.

The Directives covered by this Declaration are as detailed below:

2006/42/EC	Machinery Directive.
2004/108/EC.	Electromagnetic Compatibility Directive, Annex IV
93/68/EC.	The CE Marking Directive.
2011/65/EU. & 2015/863/EU.	The Restriction of the Use of certain Hazardous Substances in Electrical Equipment (RoHS) Directive
2002/96/EC	as amended by 2003/108/EC The Waste Electrical and Electronic Equipment (WEEE) Directive.

And is in conformity with the applicable requirements of the following documents

EN 500 -1:2006
EN 500 -4:2006

Product Details

Description:	Hulk Petrol Engined Compactor Plate
Evolution Model No:	COMPACT24HP
Factory Model No:	XZ-10A/JF154
Brand Name:	EVOLUTION
Voltage:	Petrol
Input:	

The technical documentation required to demonstrate that the product meets the requirements of directive has been compiled and is available for inspection by the relevant enforcement authorities, and verifies that our technical file contains the documents listed above and that they are the correct standards for the product as detailed above.

Name and address of technical documentation holder.



Signed:  Print: Matthew Gavins: Operations Director Year that CE was first applied

Date: 27/01/13

UK: Evolution Power Tools Ltd. Venture One, Longacre Close, Holbrook Industrial Estate, Sheffield, S20 3FR.

FR: Evolution Power Tools SAS. 61 Avenue Lafontaine, 33560, Carbon-Blanc, Bordeaux, France.

HULK ELECTRO PARTS DIAGRAM

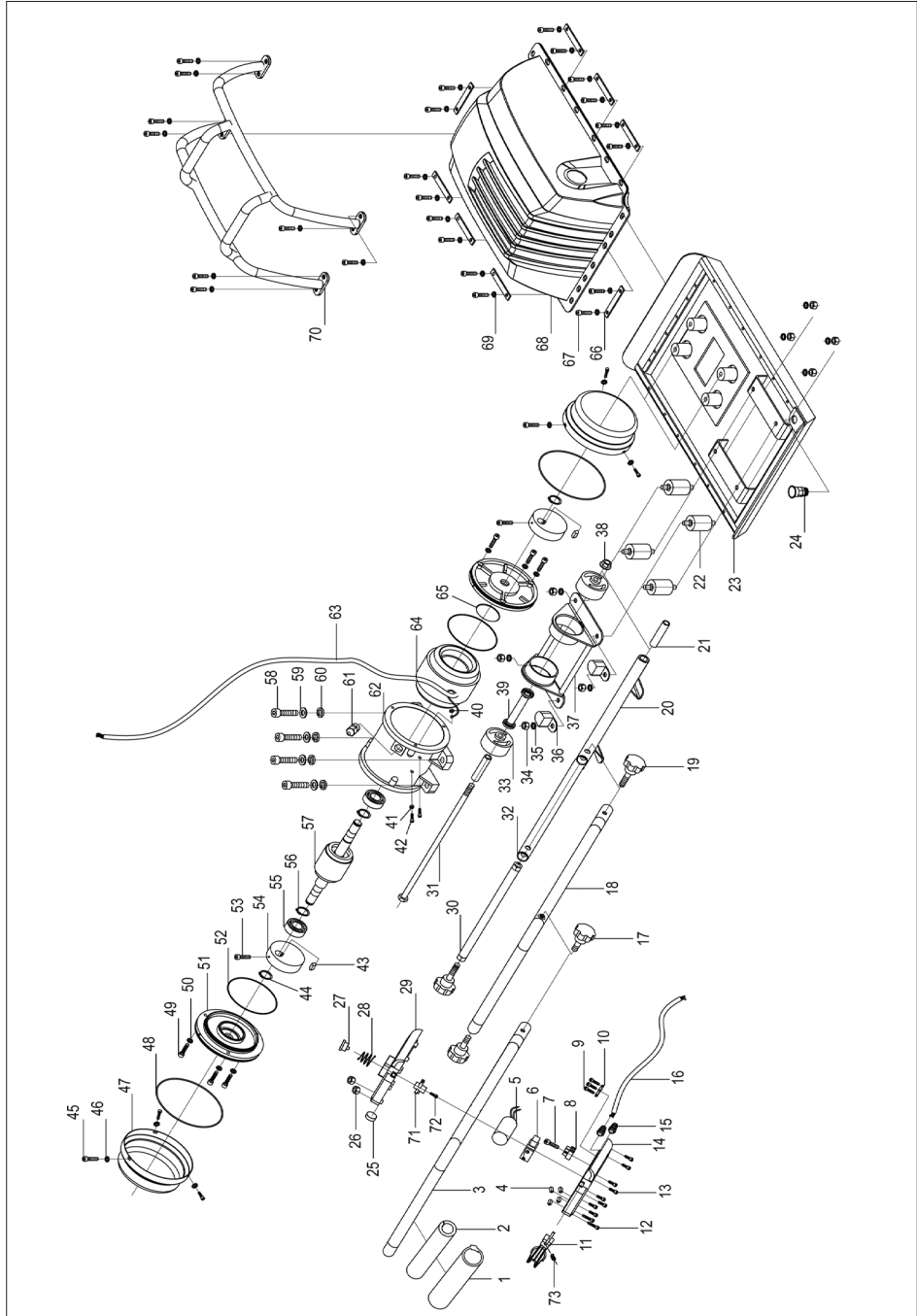

EC DECLARATION OF CONFORMITY

In accordance with EN ISO 17050-1:2004

HULK ELECTRO



The manufacturer of the product covered by this Declaration is:

UK: Evolution Power Tools Ltd. Venture One, Longacre Close, Holbrook Industrial Estate, Sheffield, S20 3FR.

FR: Evolution Power Tools SAS. 61 Avenue Lafontaine, 33560, Carbon-Blanc, Bordeaux, France.

The manufacturer hereby declares that the machine as detailed in this declaration fulfils all the relevant provisions of the Machinery Directive and other appropriate directives as detailed below. The manufacture further declares that the machine as detailed in this declaration, where applicable, fulfils the relevant provisions of the Essential Health and Safety requirements.

The Directives covered by this Declaration are as detailed below:

2006/42/EC	Machinery Directive.
2014/30/EU	Electromagnetic Compatibility Directive.
2011/65/EU. & 2015/863/EU.	The Restriction of the Use of certain Hazardous Substances in Electrical Equipment (RoHS) Directive
2002/96/EC	as amended by 2003/108/EC The Waste Electrical and Electronic Equipment (WEEE) Directive.

And is in conformity with the applicable requirements of the following documents

EN 500 – 1:2006
EN 500 – 4:2006
EN 60204 – 1:2006
EN 55014-1: 2006+A1+A2
EN 55014-2: 2015
EN 61000-3-2:2006/+A1:2009/+A2:2009
EN 61000-3-3:2008

Product Details

Description:	Hulk Electro Compaction Plate
Evolution Model No:	COMPACT110V COMPACT230V COMPACT230VEU
Factory Model No:	XZ-5
Brand Name:	EVOLUTION
Voltage:	110V or 230V ~ 50Hz
Input:	780W

The technical documentation required to demonstrate that the product meets the requirements of directive has been compiled and is available for inspection by the relevant enforcement authorities, and verifies that our technical file contains the documents listed above and that they are the correct standards for the product as detailed above.

Name and address of technical documentation holder.

Signed:  Print: Matthew Gavins - Group Chief Executive
Date: 01/03/2016

CE 12

UK: Evolution Power Tools Ltd. Venture One, Longacre Close, Holbrook Industrial Estate, Sheffield, S20 3FR.

FR: Evolution Power Tools SAS. 61 Avenue Lafontaine, 33560, Carbon-Blanc, Bordeaux, France.



UK HQ

Evolution Power Tools,
Venture One, Longacre Close,
Holbrook Industrial Estate,
Sheffield, S20 3FR, UK

TEL: +44 (0) 114 251 1022
FAX: +44 (0) 114 247 3339

FRANCE HQ

Evolution Power Tools,
61 Avenue Lafontaine, 33560,
Carbon-Blanc,
France

TÉL: + 33 (0)5 57 30 61 89
FAX: + 33 (0)5 57 30 61 94

USA HQ

Evolution Power Tools LLC,
8363 Research Drive,
Davenport, Iowa 52806
U.S.A

TEL: (Toll Free) 866-EVO-TOOL
FAX: 563.386.8010