

evolution®

evolutionpowertools.com

R210 SMS

R210 SMS +

Original Instructions

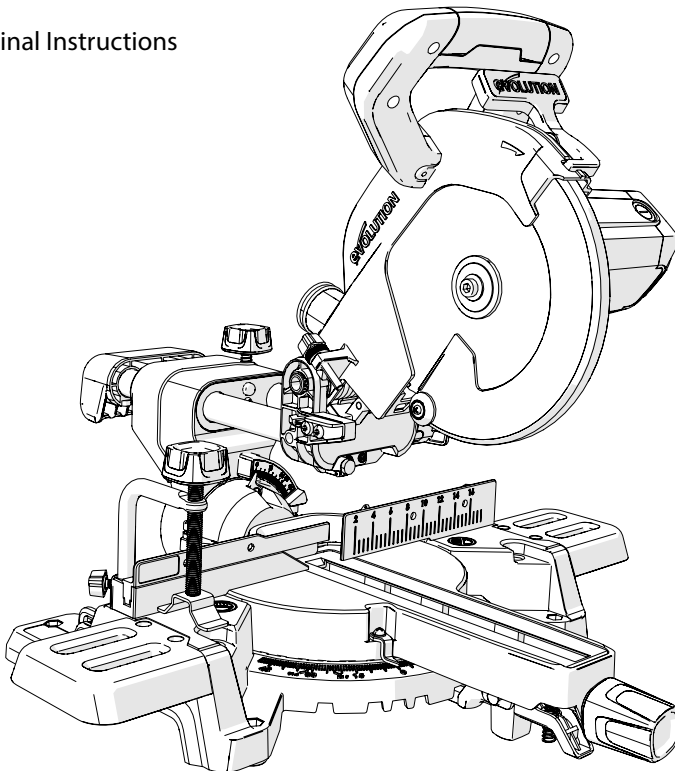

GB2438285

TABLE OF CONTENTS

Introduction	3	Mitre Angle Pointer Adjustment	25
Warranty	3	Unlatching & Raising The Cutting Head	26
Machine Specifications	4		
Safety Labels & Symbols	5	Installing The Blade	26
Intended Use Of This Power Tool	5		
Prohibited Use Of This Power Tool	5	The Laser	27
		Laser Safety	27
Safety Precautions	6	Laser Adjustment	28
Electrical Safety	6	Permanently Mounting The Mitre Saw	28
Outdoor Use	6	For Portable Use	29
General Power Tool Safety Instructions	6	Front Clamp	29
Health Advice	8		
Specific Safety Instructions	8	Operation Instructions	29
Personal Protective Equipment (PPE)	9	Body & Hand Positioning	29
Safe Operation	10	On/Off Trigger Switch	29
Perform Cuts Correctly & Safely	10	Preparing To Make A Cut	30
Additional Safety Advice	10	Chop Cutting	30
		Slide Cutting	30
Getting Started	11	Mitre Cutting	31
Unpacking	11	Bevel Cutting	31
Serial No. / Batch Code	11	Compound Cutting	31
Additional Accessories	12	Crown Moulding Cutting	32
Items Supplied	13	Cutting Bowed Material	32
Machine Overview	14	Clearing Jammed Material	32
Assembly Diagrams	16	Optional Evolution Accessories	32
Saw Set Up Diagrams	18		
Saw Usage Diagrams	20	Assembly Safety Checks	33
		Final Safety Checks	33
Assembly & Preparation	22		
Tools Needed	22	Maintenance	34
		Environmental Protection	34
Checking & Adjusting	24	EC Declaration of Conformity	35
Bevel Angles	24		
0° Bevel Stop Adjustment	24		
0° Bevel Pointer Adjustment	24		
45° Bevel Stop Adjustment	24		
The Depth Stop	25		
The Sliding Upper Fence Section	25		
Machine Fence Alignment	25		

(1.3) IMPORTANT

Please read these operating and safety instructions carefully and completely.

For your own safety, if you are uncertain about any aspect of using this equipment please access the relevant technical helpline, the number of which can be found on the Evolution Power Tools website.

We operate several helplines throughout our worldwide organization, but technical help is also available from your supplier.

WEB: www.evolutionpowertools.com

EMAIL: customer.services@evolutionpowertools.com

WARRANTY

(1.4) Congratulations on your purchase of an Evolution Power Tools Machine. Please complete your product registration 'online' as explained on the leaflet included with this machine.

This will enable you to validate your machine's warranty period via Evolution's website by entering your details and thus ensure prompt service if ever needed.

We sincerely thank you for selecting a product from Evolution Power Tools.

MACHINE SPECIFICATIONS
R210SMS
R210SMS+

MACHINE		
Motor (220-240V ~ 50 Hz)	1500W	1500W
Motor (110V ~ 50 Hz)	1500W	1500W
Speed No Load	3750 min ⁻¹	3750 min ⁻¹
Weight (Net)	11.2kg	11.2kg
Dust Port Diameter	36mm	36mm
Tool Dimensions (H x W x L) (0° / 0°) (Note: Dimensions taken with saw head down.)	314 x 575 x 610mm	314 x 575 x 610mm
Cable Length	2m	3m

CUTTING CAPACITIES		
Mild Steel Plate - Max Thickness	6mm	6mm
Mild Steel Box Section - Max Wall Thickness (50mm mild steel box section.)	3mm	3mm
Wood – Max section	230 x 65 mm	230 x 65 mm
Minimum size work-piece (Note: Any work-piece smaller than the recommended minimum work-piece requires additional support before cutting.)	L:145 x W:20 x D:3mm	L:145 x W:20 x D:3mm

MAXIMUM CUTTING ANGLES		
Mitre	50° - 50°	50° - 50°
Bevel	0° - 45°	0° - 45°

MITRE	BEVEL	MAX. WIDTH OF CUT	MAX. DEPTH OF CUT
0°	0°	230mm (9-1/16 In.)	65mm (2-9/16 In.)
0°	45°	230mm (9-1/16 In.)	38mm (1-1/2 In.)
45°	0°	150mm (5-29/32 In.)	65mm (2-9/16 In.)
45°	45°	150mm (5-29/32 In.)	38mm (1-1/2 In.)

BLADE DIMENSIONS		
Diameter	210mm	210mm
Bore	25.4mm	25.4mm
Thickness	1.7mm	1.7mm
No. of Teeth	20	24

LASER	
Laser Class	Class 2
Laser Source	Laser Diode
Laser Output Power (Max)	≤1mW
Wave Length (Nm)	650

NOISE EMISSION DATA*	
Sound Pressure L _{pA} (No-Load)	110V: 95.7 dB(A) / 220-240V: 96.5dB(A)
Sound Power Level L _{WA} (No-Load)	110V: 108.7 dB(A) / 220-240V: 109.5dB(A)
Uncertainty, K _{pA} & K _{WA}	K=3 dB(A)

*Noise emission test according to EN 62841-1 & EN 62841-3-9.

(1.8) SAFETY LABELS & SYMBOLS

WARNING: Do not operate this machine if warning and/or instruction labels are missing or damaged. Contact Evolution Power Tools for replacement labels.

Note: All or some of the following symbols may appear in the manual or on the product.

Symbol	Description
V	Volts
A	Amperes
Hz	Hertz
min ⁻¹ (RPM)	Speed
~	Alternating Current
n _o	No Load Speed
	Wear Safety Goggles
	Wear Ear Protection
	Do Not Touch, Keep hands away
	Wear Dust Protection
	Wear Hand Protection
CE	CE certification
	Waste electrical and electronic equipment
	Read Manual
	WARNING
	laser Warning
	Double Insulation Protection
	Fuse
	Trim and Waste Collection & Recycling

INTENDED USE OF THIS POWER TOOL

WARNING: This product is a Multi-material sliding mitre saw and has been designed to be used with genuine Evolution blades rated for this machine. Only use blades designed for use in this machine and/or those recommended specifically by Evolution Power Tools Ltd.

WHEN FITTED WITH A CORRECT BLADE THIS MACHINE CAN BE USED TO CUT:

- Wood, Wood derived products (MDF, Chipboard, Plywood, Blockboard, Hardboard etc),
- Wood with nails,
- 50mm mild steel box section with 3mm wall at HB 200-220,
- 6mm mild steel plate at HB 200-220.

Note: Wood containing non galvanised nails or screws, with care, can be safely cut.

Note: Not recommended for cutting galvanised materials or wood with embedded galvanised nails. **Cutting galvanised steel may reduce blade life.**

PROHIBITED USE OF THIS POWER TOOL

WARNING: This product is a Multi-material sliding mitre saw and must only be used as such. It must not be modified in any way, or used to power any other equipment or drive any other accessories other than those mentioned in this Instruction Manual.

(1.13) WARNING: This product is not intended for use by persons (including children) with reduced physical, sensory or mental capabilities, or lack of experience and knowledge, unless they have been given supervision or instruction concerning the safe use of the product by a person responsible for their safety and who is competent in its safe use.

SAFETY PRECAUTIONS

(1.14) ELECTRICAL SAFETY

This machine is fitted with the correct moulded plug and mains lead for the designated market. If the supply cord is damaged, it must be replaced by a special cord or assembly available from the manufacturers or its service agent.

(1.15) OUTDOOR USE

WARNING: For your protection if this tool is to be used outdoors it should not be exposed to rain, or used in damp locations. Do not place the tool on damp surfaces. Use a clean, dry workbench if available. For added protection use a residual current device (R.C.D.) that will interrupt the supply if the leakage current to earth exceeds 30mA for 30ms. Always check the operation of the residual current device (R.C.D.) before using the machine. If an extension cable is required it must be a suitable type for use outdoors and so labelled. The manufacturers instructions should be followed when using an extension cable.

(2.1) POWER TOOL GENERAL SAFETY INSTRUCTIONS

WARNING: When using electric tools basic safety precautions should always be followed to reduce the risk of fire, electric shock and personal injury including the following.

Note: This power tool should not be powered on continuously for a long time.

WARNING: Read all safety warnings and instructions before attempting to operate this product and save these instructions.

Failure to follow the warnings and instructions may result in electric shock, fire and/or serious injury.

SAVE ALL WARNINGS & INSTRUCTIONS FOR FUTURE REFERENCE

The term "power tool" in the warnings refers to your mains-operated (corded) power tool or battery-operated (cordless) power tool.

(2.2) 1. General Power Tool Safety Warnings [Work area safety]

- a) Keep work area clean and well lit.** Cluttered or dark areas invite accidents.
- b) Do not operate power tools in explosive atmospheres, such as in the presence of flammable liquids, gasses or dust.** Power tools create sparks which may ignite the dust or fumes.
- c) Keep children and bystanders away while operating power tool.** Distractions can cause you to lose control.
- d) Do not use this machine in an enclosed room.**

(2.3) 2. General Power Tool Safety Warnings [Electrical Safety]

- a) Power tool plugs must match the outlet. Never modify the plug in any way. Do not use any adapter plugs with earthed (grounded) power tools.**

Unmodified plugs and matching outlets will reduce the risk of electric shock.

- b) Avoid body contact with earthed or grounded surfaces, such as pipes, radiators, ranges and refrigerators.** There is an increased risk of electric shock if your body is earthed or grounded.

c) Do not expose power tools to rain or wet conditions. Water entering a power tool will increase the risk of electric shock.

- d) Do not abuse the cord. Never use the cord for carrying, pulling or unplugging the power tool. Keep cord away from heat, oil, sharp edges or moving parts.**

Damaged or entangled cords increase the risk of electric shock) When operating a power tool outdoors, use an extension cord suitable for outdoor use. Use of a cord suitable for outdoor use reduces the risk of electric shock.

- e) If operating a power tool in a damp location is unavoidable, use a residual current device (RCD) protected supply.** Use of an RCD reduces the risk of electric shock.

(2.4) 3) General Power Tool Safety Warnings [Personal Safety].

- a) Stay alert, watch what you are doing and use common sense when operating a**

power tool. Do not use a power tool while you are tired or under the influence of drugs, alcohol or medication. A moment of inattention while operating power tools may result in serious personal injury.

b) Use personal protective equipment. Always wear eye protection to prevent injury from sparks and chippings. Protective equipment such as dust masks, non-skid safety shoes, hard hat or hearing protection used for appropriate conditions will reduce personal injuries.

c) Prevent unintentional starting. Ensure the switch is in the off-position before connecting to power source and or battery pack, picking up or carrying the tool.

Carrying power tools with your finger on the switch or energising the power tools that have the switch on invites accidents.

d) Remove any adjusting key or wrench before turning the power tool on.

A wrench or key left attached to a rotating part of a power tool may result in personal injury.

e) Do not overreach. Keep proper footing and balance at all times. This enables better control of the power tool in unexpected situations.

f) Dress properly. Do not wear loose clothing or jewellery. Keep your hair, clothing and gloves away from moving parts. Loose clothes, jewellery or long hair can be caught in moving parts.

g) If devices are provided for the connection of dust extraction and collection facilities, ensure that these are connected and properly used.

Use of dust collection can reduce dust-related hazards.

h) When cutting metal, gloves should be worn before handling to prevent from getting burnt from hot metal.

(2.5) 4) General Power Tool Safety Warnings [Power tool use and care].

a) Do not force the power tool. Use the correct power tool for your application.

The correct power tool will do the job better and safer at a rate for which it was designed.

b) Do not use the power tool if the switch does not turn it on or off. Any power tool that cannot be controlled with the switch is dangerous and must be repaired.

c) Disconnect the power tool from the power source and/or battery pack from the power tool before making any adjustments, changing accessories, or storing power tools.

Such preventative safety measures reduce the risk of starting the power tool accidentally.

d) Store idle power tools out of the reach of children and do not allow persons unfamiliar with the power tool or these Instructions to operate the power tool. Power tools are dangerous in the hands of untrained users.

e) Maintain power tools. Check for misalignment or binding of moving parts, breakage of moving parts and any other condition that may affect the power tools operation. If damaged, have the power tool repaired before use. Many accidents are caused by poorly maintained power tools.

f) Keep cutting tools sharp and clean. Properly maintained cutting tools with sharp cutting edges are less likely to bind and are easier to control.

g) Use the power tool, accessories and tool bits etc. in accordance with these instructions, taking into account the working conditions and the work to be performed. Use of the power tool for operations different from those intended could result in a hazardous situation.

h) Keep handles and grasping surfaces dry, clean and free from oil and grease. Slippery handles and grasping surfaces do not allow for safe handling and control of the tool in unexpected situations.

(2.6) 5) General Power Tool Safety Warnings [Service] **a) Have your power tool serviced by a qualified repair person using only identical replacement parts.** This will ensure that the safety of the power tool is maintained.

If the supply cord of this power tool is damaged, it must be replaced by a specially prepared supply cord available through the service organization.

(2.7) HEALTH ADVICE

WARNING: If you suspect that paint on surfaces in your home contains lead seek professional advice. Lead based paints should only be removed by a professional and you should not attempt to remove it yourself.

Once the dust has been deposited on surfaces, hand to mouth contact can result in the ingestion of lead. Exposure to even low levels of lead can cause irreversible brain and nervous system damage. The young and unborn children are particularly vulnerable.

(2.8) WARNING: Some wood and wood type products, especially MDF (Medium Density Fibreboard), can produce dust that may be hazardous to your health. We recommend the use of an approved face mask with replaceable filters when using this machine, in addition to using the dust extraction facility.

(3.5) MITRE SAW SPECIFIC SAFETY

- **Not to use saw blades manufactured from high speed steel.**
- **Use only the saw with guards in good working order and properly maintained, and in position.**
- **Always to clamp work-pieces to the saw table.**

a) Mitre saws are intended to cut wood or wood-like products, they cannot be used with abrasive cut-off wheels for cutting ferrous material such as bars, rods, studs, etc. Abrasive dust causes moving parts such as the lower guard to jam. Sparks from abrasive cutting will burn the lower guard, the kerf insert and other plastic parts.

b) Use clamps to support the workpiece whenever possible. If supporting the workpiece by hand, you must always keep your hand at least 150mm from either side of the saw blade. Do not use this saw to cut pieces that are too small to be securely clamped or held by hand. If your hand is placed too close to the saw blade, there is an increased risk of injury from blade contact.

c) The workpiece must be stationary and clamped or held against both the fence and the table. Do not feed the workpiece into the blade or cut "freehand" in any way. Unrestrained or moving workpieces could be thrown at high speeds, causing injury.

d) Push the saw through the workpiece. Do not pull the saw through the workpiece. To make a cut, raise the saw head and pull

it out over the workpiece without cutting, start the motor, press the saw head down and push the saw through the workpiece. Cutting on the pull stroke is likely to cause the saw blade to climb on top of the workpiece and violently throw the blade assembly towards the operator.

NOTE: The above warning is omitted for a simple pivoting arm mitre saw.

e) Never cross your hand over the intended line of cutting either in front or behind the saw blade. Supporting the workpiece "cross handed" i.e. holding the workpiece to the right of the saw blade with your left hand or vice versa is very dangerous.

f) Do not reach behind the fence with either hand closer than 150mm from either side of the saw blade, to remove wood scraps, or for any other reason while the blade is spinning. The proximity of the spinning saw blade to your hand may not be obvious and you may be seriously injured.

g) Inspect your workpiece before cutting. If the workpiece is bowed or warped, clamp it with the outside bowed face toward the fence. Always make certain that there is no gap between the workpiece, fence and table along the line of the cut. Bent or warped workpieces can twist or shift and may cause binding on the spinning saw blade while cutting. There should be no nails or foreign objects in the workpiece.

h) Do not use the saw until the table is clear of all tools, wood scraps, etc., except for the workpiece. Small debris or loose pieces of wood or other objects that contact the revolving blade can be thrown with high speed.

i) Cut only one workpiece at a time. Stacked multiple workpieces cannot be adequately clamped or braced and may bind on the blade or shift during cutting.

j) Ensure the mitre saw is mounted or placed on a level, firm work surface before use. A level and firm work surface reduces the risk of the mitre saw becoming unstable.

k) Plan your work. Every time you change the bevel or mitre angle setting, make sure the adjustable fence is set correctly to support the workpiece and will not interfere with the blade or the guarding system.

Without turning the tool “ON” and with no workpiece on the table, move the saw blade through a complete simulated cut to assure there will be no interference or danger of cutting the fence.

NOTE: The phrase “bevel or” does not apply for saws without bevel adjustment.

l) Provide adequate support such as table extensions, saw horses, etc. for a workpiece that is wider or longer than the table top. Workpieces longer or wider than the mitre saw table can tip if not securely supported. If the cut-off piece or workpiece tips, it can lift the lower guard or be thrown by the spinning blade.

m) Do not use another person as a substitute for a table extension or as additional support. Unstable support for the workpiece can cause the blade to bind or the workpiece to shift during the cutting operation pulling you and the helper into the spinning blade.

n) The cut-off piece must not be jammed or pressed by any means against the spinning saw blade. If confined, i.e. using length stops, the cut-off piece could get wedged against the blade and thrown violently.

o) Always use a clamp or a fixture designed to properly support round material such as rods or tubing. Rods have a tendency to roll while being cut, causing the blade to “bite” and pull the work with your hand into the blade.

p) Let the blade reach full speed before contacting the workpiece. This will reduce the risk of the workpiece being thrown.

q) If the workpiece or blade becomes jammed, turn the mitre saw off. Wait for all moving parts to stop and disconnect the plug from the power source and/or remove the battery pack. Then work to free the jammed material. Continued sawing with a jammed workpiece could cause loss of control or damage to the mitre saw.

r) After finishing the cut, release the switch, hold the saw head down and wait for the blade to stop before removing the cut-off piece. Reaching with your hand near the coasting blade is dangerous.

s) Hold the handle firmly when making an incomplete cut or when releasing the switch before the saw head is completely in the down position. The braking action of the saw may cause the saw head to be suddenly pulled downward, causing a risk of injury.

NOTE: The above warning applies only for mitre saws with a brake system.

BLADE SAFETY

WARNING: Rotating saw blades are extremely dangerous and can cause serious injury and amputation. Always keep fingers and hands at least 150mm (6”) away from the blade at all times. Never attempt to retrieve sawn material until the cutting head is in the raised position, the guard is fully closed and the saw blade has stopped rotating. Only use saw blades that are recommended by the manufacturer and as detailed in this manual and that comply with the requirements of EN 847-1.

- Only use genuine Evolution blades rated for this machine.
- Do not use saw blades that are damaged or deformed as they could shatter and cause serious injury to the operator or bystanders.
- If the table insert becomes damaged or worn it must be replaced with an identical one available from the manufacturer.

(3.6) PERSONAL PROTECTIVE EQUIPMENT (PPE)

Hearing protection should be worn in order to reduce the risk of induced hearing loss. Eye protection should be worn in order to prevent the possibility of the loss of sight from ejected chippings.

Respiratory protection is also advised as some wood and wood type products especially MDF (Medium Density Fibreboard) can produce dust that can be hazardous to your health. We recommend the use of an approved face mask with replaceable filters when using this machine in addition to using the dust extraction facility. Gloves should be worn when handling blades or rough material. Heat resistant gloves should

be worn when handling metallic materials which may be hot. It is recommended that saw blades should be carried in a holder wherever practicable. It is not advisable to wear gloves when operating the mitre saw.

(3.7) **SAFE OPERATION**

Always ensure that you have selected the correct saw blade for the material being cut. **Do not** use this mitre saw to cut materials other than those specified in this Instruction Manual.

When transporting a mitre saw ensure that the cutting head is locked in the 90° down position (if a sliding mitre saw ensure that the slide bars are locked). Lift the machine by gripping the outer edges of the base with both hands (if a sliding mitre saw, transport using the handles provided). Under no circumstances shall the machine be lifted or transported using the retractable guard or any part of its operating mechanism. Bystanders and other colleagues must be kept at a safe distance from this saw. Cut debris can, in some circumstances, be ejected forcibly from the machine, posing a safety hazard to people standing nearby.

Before each use check the operation of the retractable guard and its operating mechanism ensuring that there is no damage, and that all moving parts operate smoothly and correctly. Keep the work bench and floor area clear of all debris including sawdust, chips and off-cuts. Always check and ensure that the speed marked on the saw blade is at least equal to the no load speed marked on the mitre saw. Under no circumstances shall a saw blade be used that is marked with a speed that is less than the no-load speed marked on the mitre saw.

Where it is necessary to use spacer or reducing rings these must be suitable for the intended purpose and only as recommended by the manufacturer.

If the mitre saw is fitted with a laser it shall not be replaced with a different type. If the laser fails to operate it shall be repaired or replaced by the manufacturer or authorised agent.

The saw blade shall only be replaced as detailed in this instruction manual. Never attempt to retrieve off-cuts or any other part of the work-piece until the cutting head is in the raised position, the guard is fully closed and the saw blade has stopped rotating.

(3.8) **PERFORM CUTS CORRECTLY & SAFELY**

Wherever practicable always secure the work-piece to the saw table using the work clamp where provided.

Always ensure that before each cut the mitre saw is mounted in a stable position.

If needed the mitre saw can be mounted on a wooden base or work bench or attached to a mitre saw stand as detailed in this instruction manual. Long work-pieces should be supported on the work supports provided or on appropriate additional work supports.

(2.8) WARNING: The operation of any mitre saw can result in foreign objects being thrown towards your eyes, which could result in severe eye damage. Before beginning power tool operation, always wear safety goggles or safety glasses with side shield or a full face shield when needed.

WARNING: If any parts are missing, do not operate your mitre saw until the missing parts are replaced. Failure to follow this rule could result in serious personal injury.

(3.9) **ADDITIONAL SAFETY ADVICE**

CARRYING YOUR MITRE SAW

WARNING: When using electric tools basic safety precautions should always be followed to reduce the risk of fire, electric shock and personal injury including the following.

READ all these instructions before attempting to operate this product and save these instructions.

Safety Advice:

- Although compact, this mitre saw is heavy. To reduce the risk of back injury, get competent help whenever you have to lift the saw.
- Hold the tool close to your body when lifting. Bending your knees so you can lift with your legs, not your back. Lift by using the cutting handle on the head of the mitre saw and the large, orange handle on the rear of the carriage slide.
- Never carry the mitre saw by the power cord. Carrying the mitre saw by the power cord could cause damage to the insulation or the wire connections resulting in electric shock or fire.
- Before moving the mitre saw tighten the mitre and bevel locking screws and the sliding carriage locking screw to guard against sudden unexpected movement.
- Lock the cutting head in its lowest position. Ensure that the cutting head locking pin is completely engaged in its socket.

WARNING: Do not use the blade guard as a 'lifting point'. The power cord must be removed from the power supply before attempting to move the machine.

- Lock the cutting head in the down position using the cutting head locking pin.
- Loosen the Mitre Angle locking screw. Turn the table to either of its maximum settings.
- Lock the table in position using the locking screw.
- Wrap the cable around the cable guide.

(4.1) GETTING STARTED - UNPACKING

WARNING: Due to the power input of this product on start up, voltage drops may occur and this can influence other equipment (e.g. dimming lights). So for technical reasons we advise, if the mains-impedance is $Z_{max} < 0.318$ Ohm, these disturbances are not expected. If you require further clarification, you may contact your local power supply authority.

Caution: This packaging contains sharp objects. Take care when unpacking. This machine could require two persons to lift, assemble and move this machine. Remove the machine, together with the accessories supplied from the packaging. Check carefully to ensure that the machine is in good condition and account for all the accessories listed in this manual. Also make sure that all the accessories are complete. If any parts are found to be missing, the machine and its accessories should be returned together in their original packaging to the retailer. Do not throw the packaging away; keep it safe throughout the warranty period. Dispose of the packaging in an environmentally responsible manner. Recycle if possible. Do not let children play with empty plastic bags due to the risk of suffocation.

SERIAL NO. / BATCH CODE

The serial number can be found on the motor housing of the machine.

For instructions on how to identify the batch code, please contact the Evolution Power Tools helpline or go to:

www.evolutionpowertools.com

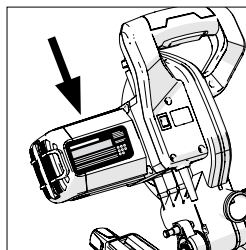

(4.3) ADDITIONAL ACCESSORIES

In addition to the standard items supplied with this machine the following accessories are also available from the Evolution online shop at www.evolutionpowertools.com or from your local retailer.

(4.4)

Description	Part No
RAGE Multi-Material TCT Blade	RAGEBLADE210MULTI
Diamond Blade	RAGEBLADE210 DIAMOND
Dust Port Adaptor	048-0258
Dust Bag	048-0259
Front Clamp	048-0260
2pc Top Clamp	048-0231
3pc Top Clamp	048-0262
Slide Rail Cover	048-0263

(4.2) ITEMS SUPPLIED

	R210SMS	R210SMS+
Product Code	048-0001 048-0002 048-0003	048-0001A 048-0002A 048-0003A
20 Tooth Blade	✓	
24 Tooth Blade		✓
2 Pc Hold Down Clamp	✓	
3 Pc Hold Down Clamp		✓
Machine Table Extensions	✓	✓
Dust Collection Bag		✓
Double Ended Hex Key (M6 & M4)	✓	✓
Instruction Manual (Assembly & Operations)	✓	✓
Rotary Table And Neck	✓	✓
Cutting Head	✓	✓
Carriage Slides	✓	✓
Mitre Locking Knob	✓	✓
Mains Cable Guide/Clamp (1 Fitted)	✓	✓
Self Tapping Cap Screw	✓	✓
Socket Headed Screws (Fitted)	✓	✓
Cable Clamp Component	✓	✓
Laser Lens Cap (Fitted)	✓	✓
Sliding Rail Protector		✓
Dust Port Adaptor		✓
Front Clamp		✓
Rear Carry Handle		✓
2m Cable	✓	
3m Cable		✓

MACHINE OVERVIEW

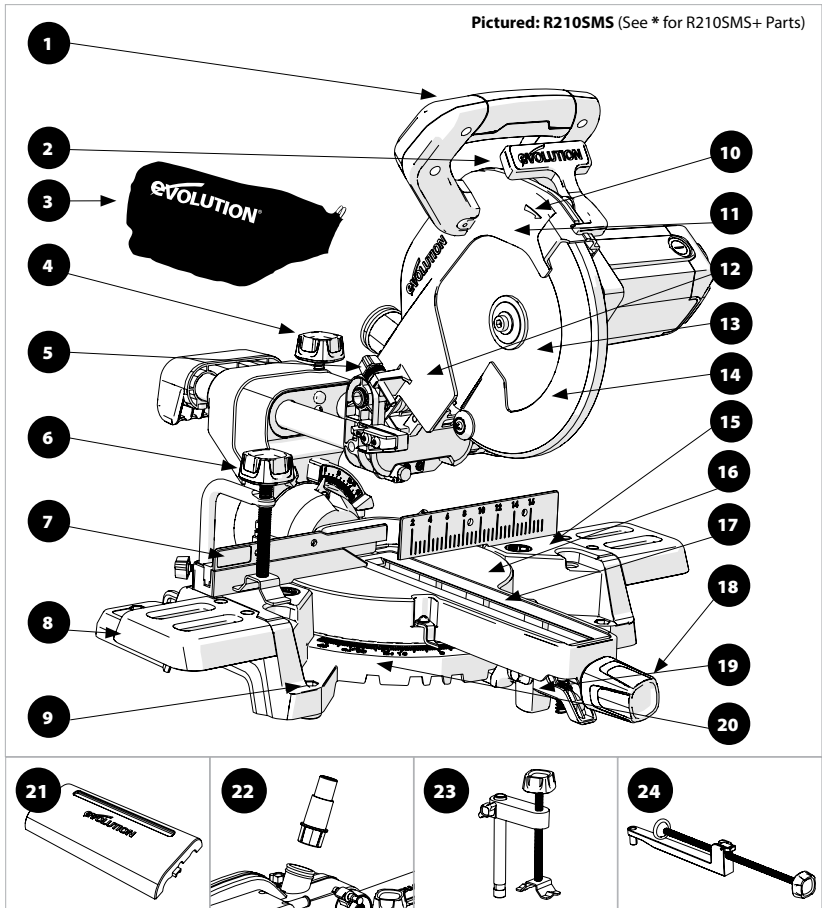

- 1. CUTTING HANDLE
- 2. BLADE GUARD LOCKING TRIGGER
- 3. **DUST BAG***
- 4. SLIDE LOCKING SCREW
- 5. DEPTH GAUGE
- 6. 2 PC HOLD DOWN CLAMP
- 7. SLIDING FENCE
- 8. MACHINE TABLE EXTENSIONS
- 9. MOUNTING HOLE (X4)
- 10. BLADE ROTATION INDICATION ARROW
- 11. UPPER BLADE GUARD
- 12. CUTTING HEAD

- 13. BLADE
- 14. LOWER BLADE GUARD
- 15. TABLE TOP
- 16. ROTARY TABLE
- 17. TABLE INSERT
- 18. MITRE HANDLE LOCKING KNOB
- 19. POSITIVE STOP LOCKING LEVER
- 20. MITRE ANGLE SCALE
- 21. **SLIDE RAIL PROTECTOR***
- 22. **DUST PORT ADAPTER***
- 23. **3 PIECE HOLD DOWN CLAMP***
- 24. **FRONT CLAMP***

*Supplied as original equipment on the R210SMS+.

Pictured: R210SMS

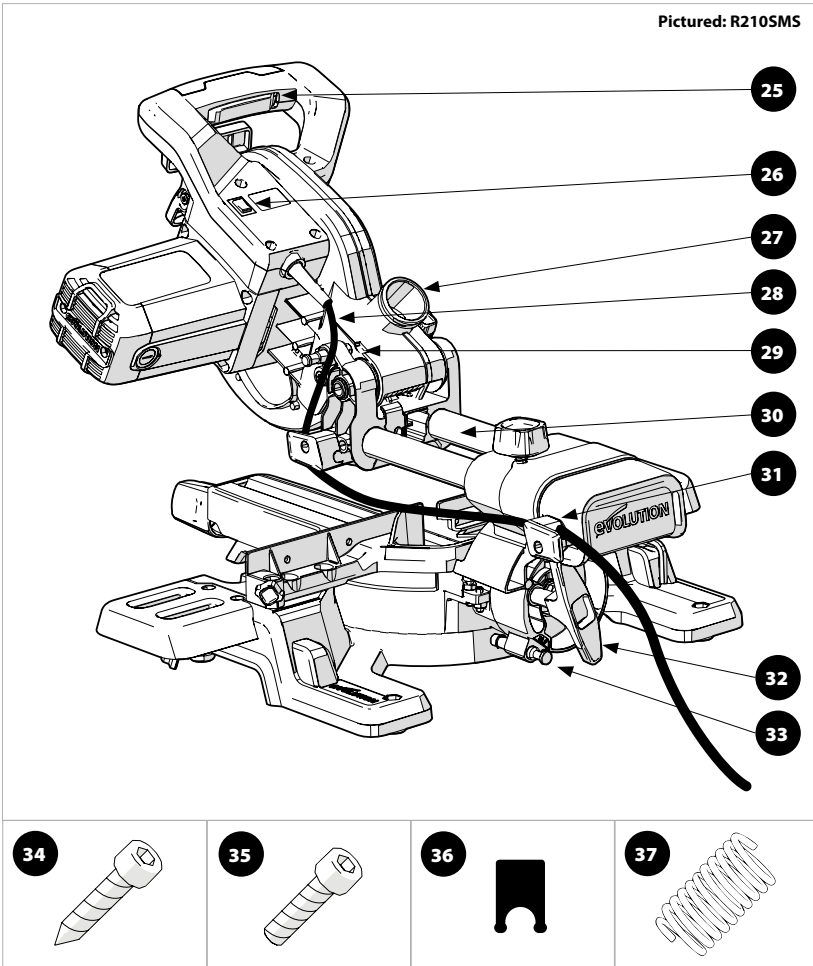

- 25. ON / OFF TRIGGER SWITCH
- 26. LASER GUIDE ON / OFF SWITCH
- 27. DUST EXTRACTION PORT
- 28. CABLE
- 29. CUTTING HEAD LOCKING PIN
- 30. REAR SLIDING CARRIAGE
- 31. CABLE GUIDE CLAMP
- 32. BEVEL LOCK HANDLE
- 33. 33.9° BEVEL PIN

- 34. M4 SELF TAPPING CAP SCREW x1
- 35. M4 SOCKET HEAD SCREW x4
- 36. CABLE GRIP COMPONENT
(FITTED TO THE CABLE GUIDE CLAMP)
- 37. ANTI-VIBRATION SPRING
(FITTED TO ITEM '4' - THE SLIDE LOCKING SCREW)

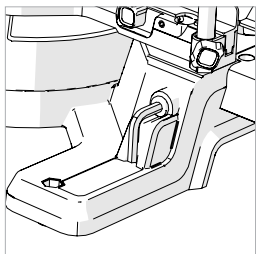

Fig. 1

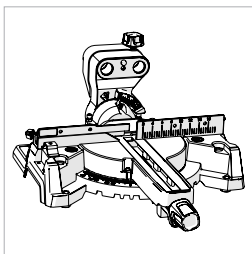

Fig. 2

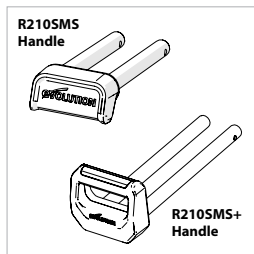

Fig. 3

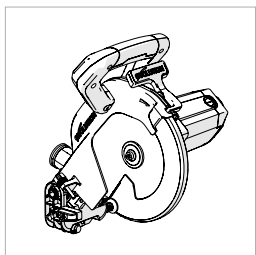

Fig. 4

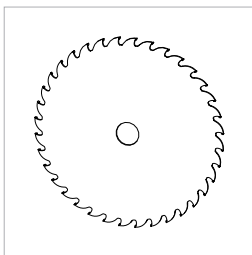

Fig. 5

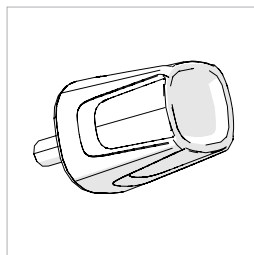

Fig. 6

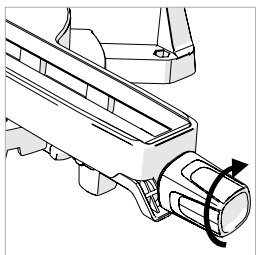

Fig. 7

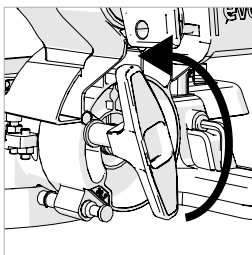

Fig. 8

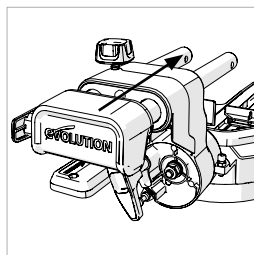

Fig. 9

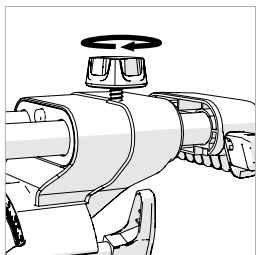

Fig. 10

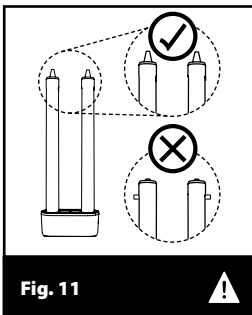

Fig. 11

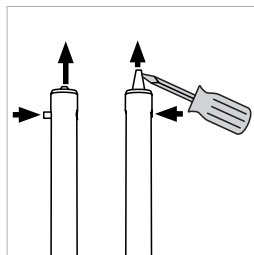

Fig. 12

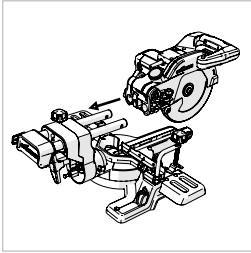

Fig. 13a

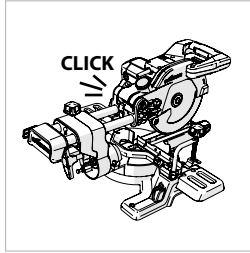

Fig. 13b

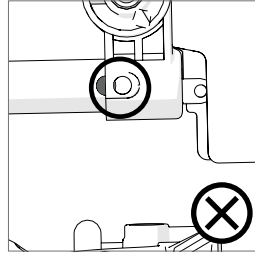

Fig. 14a

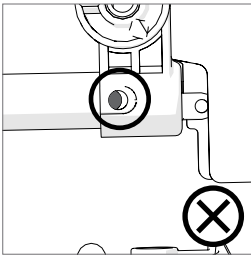

Fig. 14b

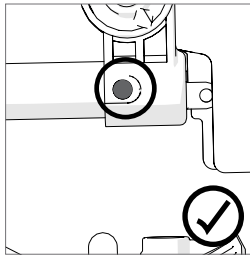

Fig. 14c

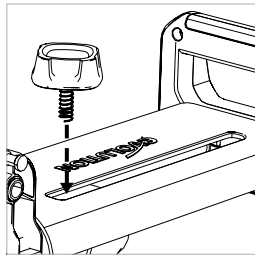

Fig. 15

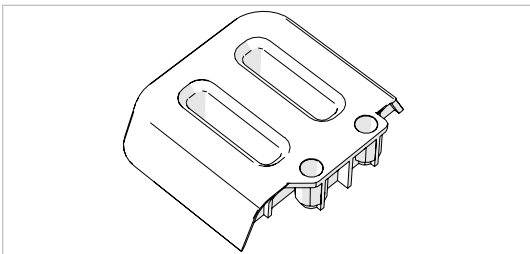

Fig. 16

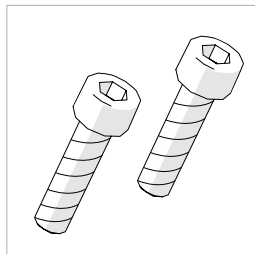

Fig. 17

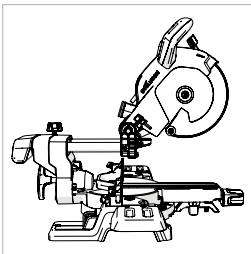

Fig. 18

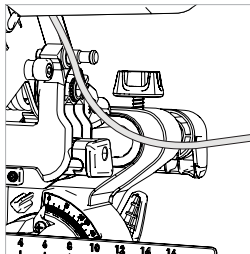

Fig. 19

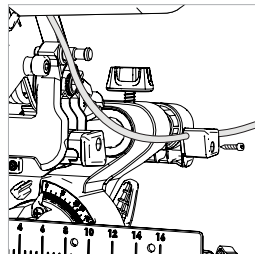

Fig. 20

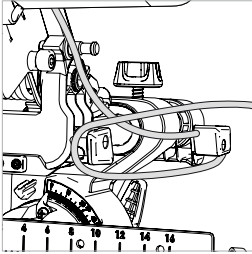

Fig. 21

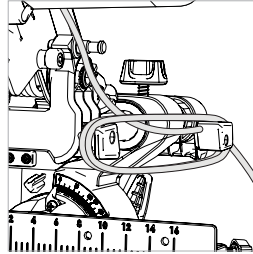

Fig. 22

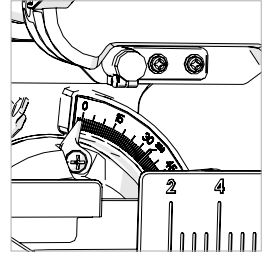

Fig. 23

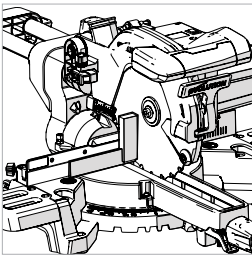

Fig. 24

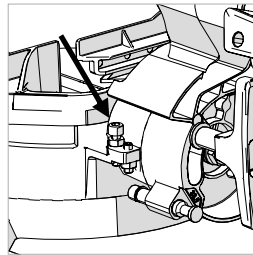

Fig. 25

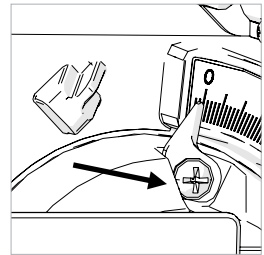

Fig. 26

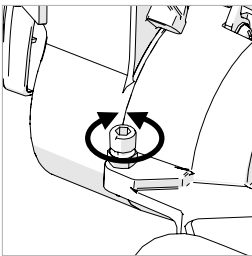

Fig. 27

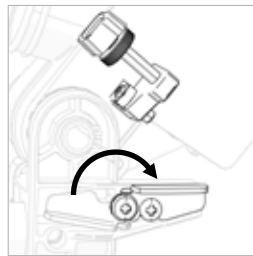

Fig. 28a

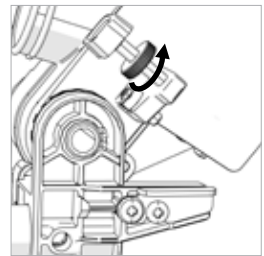

Fig. 28b

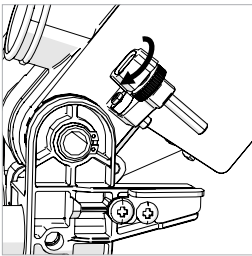

Fig. 28c

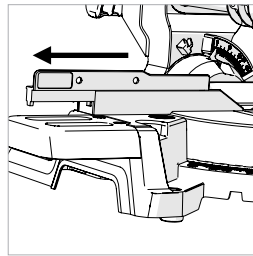

Fig. 29

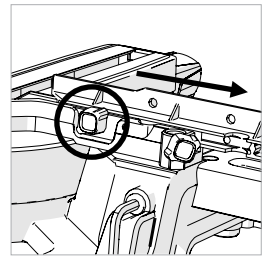

Fig. 30

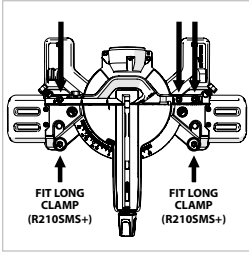

Fig. 31

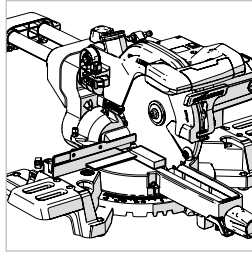

Fig. 32

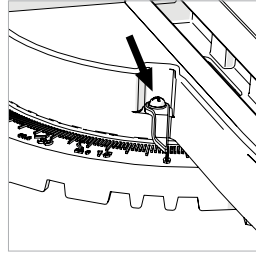

Fig. 33

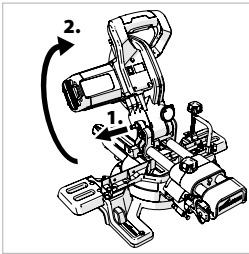

Fig. 34

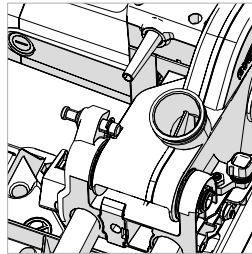

Fig. 35

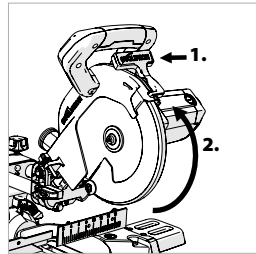

Fig. 36

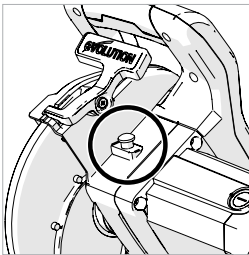

Fig. 37

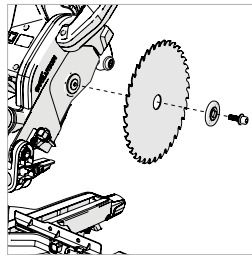

Fig. 38

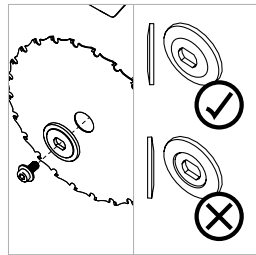

Fig. 39

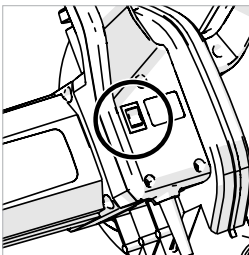

Fig. 40

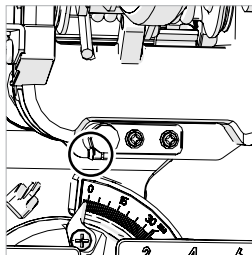

Fig. 41a

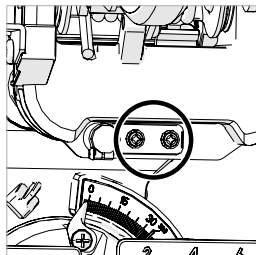

Fig. 41b

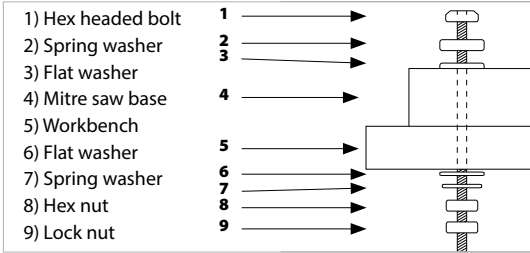

Fig. 42

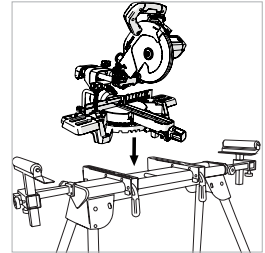

Fig. 43

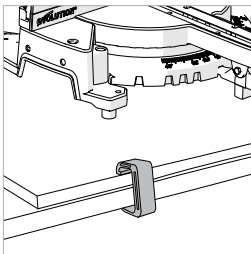

Fig. 44

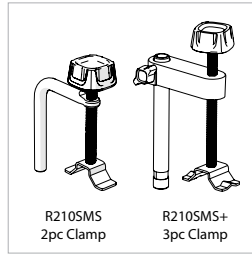

Fig. 45

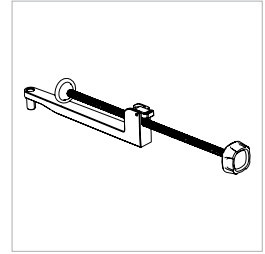

Fig. 46

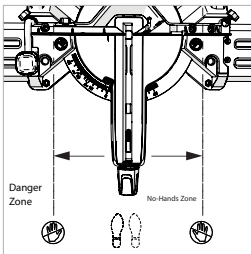

Fig. 47

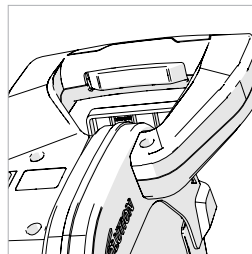

Fig. 48

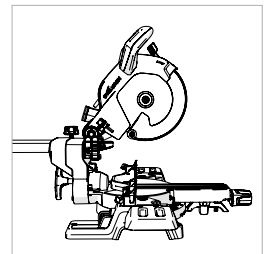

Fig. 49

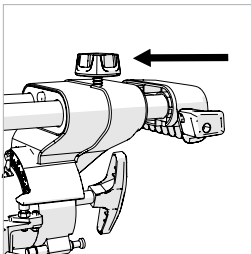

Fig. 50

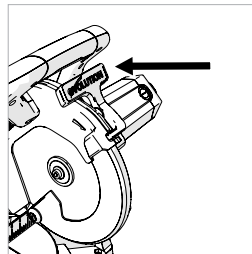

Fig. 51

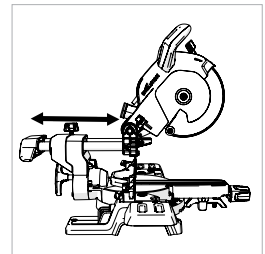

Fig. 52

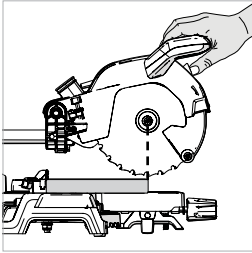

Fig. 53

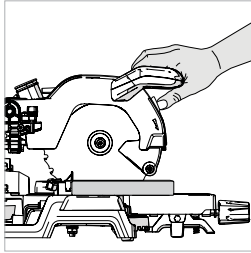

Fig. 54

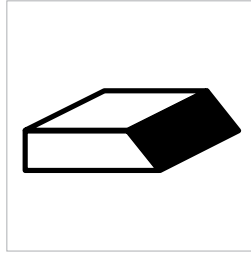

Fig. 55

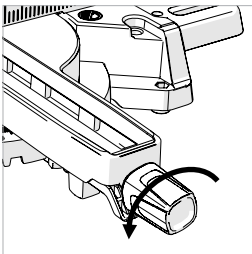

Fig. 56

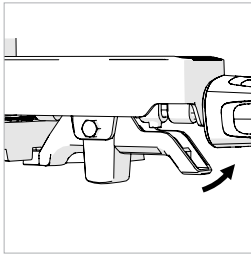

Fig. 57

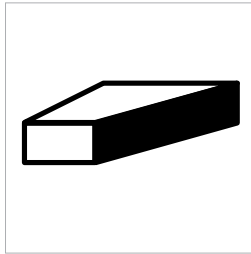

Fig. 58

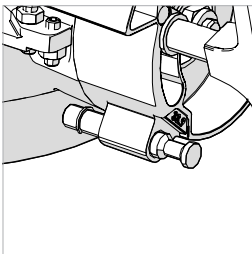

Fig. 59

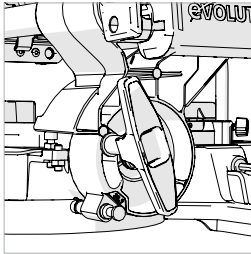

Fig. 60

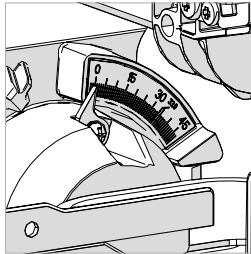

Fig. 61

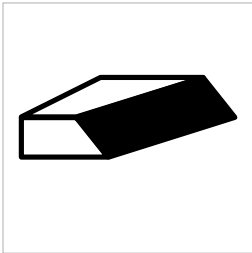

Fig. 62

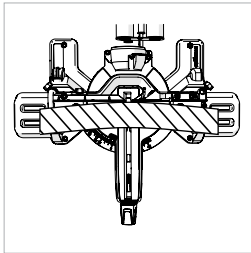

Fig. 63

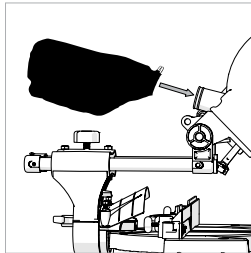
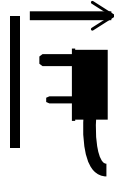

Fig. 64

(7.1) ASSEMBLY AND PREPARATION

WARNING: Always disconnect the saw from the power source before making any adjustments.



Some minor assembly is required to commission this machine.

By assembling this machine the owner/operator will gain valuable insight into its many advanced features. This should enable the operator to exploit the machines full potential once it is commissioned.

Note: Study the diagrams showing the assembled machine. You will gain valuable insight which will help you with the assembly process.

TOOLS NEEDED FOR ASSEMBLY & ADJUSTMENTS

- Hex Key – Supplied and located in a dedicated storage position on the machine. **(Fig. 1)**
- Flat Bladed Screwdriver – Not supplied.
- 10mm Spanner – Not supplied.
- 5mm Allen Key – Not supplied.

Note: The assembly process is a 'one time assembly'.

Once assembly is successfully completed no attempt to disassemble the machine should be made.

The blade and some other smaller parts also need to be fitted by the owner/operator.

Note: A safety check must be carried out once assembly is completed and before the machine is used - see page 33.

WARNING: Do not under any circumstances plug the cutting head into the power supply and try to use it as a hand held circular saw.

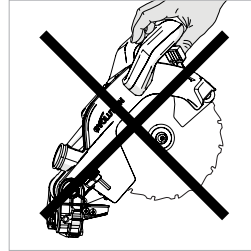

KNOW THE PARTS

There are four **(4)** main parts to be assembled (including the blade), and two **(2)** other smaller parts to be connected. Additionally the blade (supplied) will need to be fitted.

- The rotary base and bevel neck **(Fig. 2)**
- The carriage slides **(Fig. 3)**
- The cutting head (In The 'locked down Position as Removed from the Packaging) **(Fig. 4)**
- The Blade **(Fig. 5)**

Note: The Blade should be the last part to be fitted. It must only be fitted after the assemble process is completed and the machine has been subjected to the Assembly Safety Checks - see page 33.

THE MITRE LOCKING KNOB (Fig. 6)

The threaded spigot of the Mitre Locking Knob slides through a hole in the front of the Mitre Locking Handle **(Fig. 7)** and then screws into an internally threaded boss located in the base of the machine.

THE BEVEL NECK

Note: The bevel neck is supplied fitted to the Rotary table. The bevel neck should be adjusted to the 0° position.

- Slacken the Bevel Locking screw using the Bevel Locking Handle. **(Fig. 8)**
- Rotate the bevel neck to the vertical position so that it rests against the 0 degree stop.
- Tighten the Bevel Locking Handle.

INSERTING THE CARRIAGE SLIDE

IMPORTANT: If for any reason (transit damage, unpacking error, operator mistake, etc.) the locating lugs at the tip of the carriage slide arms have been 'tripped', the sliding carriage cannot be fitted into the bevel neck or onto the cutting head. The locating lugs (Fig. 11) must be reset, if either or both have been 'tripped' prematurely.

RESETTING THE LOCATING LUGS

- Gently push the protruding lug into the Carriage arm.
- Gently ease the locating lug deployment plunger forward by using a flat bladed screwdriver (not supplied) as a lever. (Fig. 12)

The carriage slides two (2) arms should be inserted through the two linear bearings contained within the bevel neck.

The carriage slide should be inserted from the back ensuring that the 'Evolution' logo is the correct way up. (Fig. 9)

- Slide the sliding carriage arms through the bevel neck for approximately half of their length.
- Screw the carriage slide locking screw into the threaded hole above the right hand arm of the carriage slide. (Fig. 10)

Note: Ensure that the anti-vibration spring is fitted underneath the hand knob before fitting the locking screw into its service position.

- Tighten the locking screw to lock the sliding carriage into the desired position.

ATTACHING THE CUTTING HEAD

- Align the cutting head with the two (2) sliding carriage arms. (Fig. 13a)
- Push the cutting head onto the Carriage arms firmly until the 'click' of the Locating Lugs deploying is heard. (Fig. 13b)

Note: The deployed locating lugs must be fully visible when viewed from the side of the cutting head. (Figs. 14a, 14b, 14c)

The Locating Lugs are coloured green to make identification easy.

FITTING THE SLIDE RAIL COVER:

Note: Make sure the cutting head is in the down right position before proceeding.

- Remove Slide Locking Screw and spring.
- With the saw's Cutting Head facing towards you, align the Slide Rail Cover's cut out channel over the right rail.
- Insert the single tab into the recess between the two rails on the rear of the Cutting Head.
- Lower the Slide Rail Cover onto the rails and click the two rear tabs into place on the rear Carry Handle.
- Re-fit the Slide Locking Screw and spring.

THE MACHINE TABLE EXTENSIONS (Fig. 16)

Note: Two (2) machine table extension pieces are provided with this machine. They are 'handed', one being for the right hand side, and one for the left hand side.

TO FIT THE TABLE EXTENSIONS:

- Carefully examine the table extension pieces to determine which is for the right hand side and which is for the left hand side.
- Remove the socket headed screws (Fig. 17) from the table using the hex key provided.
- Position the relevant Extension piece onto the table and secure it into its service position using the socket headed screws.
- Repeat for the second Extension piece.

ROUTING THE POWER CABLE

WARNING: This machine is equipped with a mains cable and a moulded plug which satisfies the regulations of the receiving country. This cable and plug, if damaged, should only be replaced with genuine Evolution replacement parts and be fitted by a competent technician.

- Ensure that the cutting head is in the down position.
- Ensure that the carriage slide is in its most forward position and locked. (Fig. 18)

From the motor the mains cable should bypass the front cable guide and then be routed rearwards (Fig. 19).

The cable should be inserted into the rear cable guide/clamp. Ensure the Cable Grip Component is inside the cable guide when the cable passes through.

This guide/clamp should then be fastened to the rear sliding carriage cross piece (right hand side) using the self tapping cap screw (included). (Fig. 20)

Note: The cable should not be tight anywhere along its length. (Fig. 21)

Raise and lower the cutting head several times and also operate the sliding carriage. Check that the cable does not become entangled with any other parts of the machine. Check also that the cable is not stretched during any of the operating procedures. To secure the cable, secure the cable using the cable clip.

Note: The cable guides can be used to provide a very convenient way of storing the mains cable on the machine (Fig. 22) when the machine itself is not being used and is perhaps in storage.

UNLATCHING AND RAISING THE CUTTING HEAD (Fig. 34)

WARNING: To avoid serious injury, NEVER perform the locking or unlocking procedure unless the saw is OFF and the blade stationary.

To release the cutting head from the locked down position:

- Gently press down on the Cutting Head Handle.
- Pull out the head latching pin (Step 1) allow the cutting head to rise to its upper position. (Step 2)

Note: The cutting head will automatically rise to the upper position once it is released from the locked down position.

- It will automatically lock in the upper position.

If release is difficult:

- Gently rock the cutting head up and down.
- At the same time twist the Head Latching Pin clockwise and pull outwards.

Note: We recommend that when the machine is not in use the cutting head is locked in its down position with the latching pin fully engaged in the open half socket which is machined into the cutting head upper surface near to the pivot point. (Fig. 35).

INSTALLING OR REMOVING A BLADE
WARNING: Only carry out this operation with the machine disconnected from the mains supply.

WARNING: Only use genuine Evolution blades or those blades specifically recommended by Evolution Power Tools and which are designed for this machine. Ensure that the maximum speed of the blade is higher than the speed of the motor.

Note: It is recommended that the operator considers wearing protective gloves when handling the blade during installation or when changing the blade.

Ensure the cutting head is in its upper position. (Fig. 36)

- Press the lower blade guard locking trigger (Step 1) and rotate the lower blade guard (Step 2) up and into the upper blade guard.

Note: Lowering the cutting head slightly will allow the lower blade guard to rotate fully into the upper blade guard giving maximum access for the operator.

- Press the black arbor lock button to lock the arbor. (Fig. 37)
- Using the supplied Hex Key, release the flange bolt and outer blade flange and the blade from the arbor. (Fig. 38)

Note: The arbor screw has a LH thread. Turn clockwise to loosen. Turn counterclockwise to tighten.

Ensure that the blade and blade flanges are clean and free from any contamination.

- The inner blade flange should be left in place, but if it is removed for cleaning it must

be replaced the same way round as it was removed from the machine.

WARNING: To safely install Evolution Multipurpose blades the inner blade flange must be installed with the 25.4mm boss facing to the outside. (Fig. 39)

Install the new blade. Make sure the rotation arrow on the blade matches the clockwise rotation arrow on the upper guard.

Note: The blade teeth should always point downward at the front of the saw.

- Install the outer blade flange and flange bolt. (Fig. 39)
- Lock the arbor and tighten the arbor screw using moderate force, but do not overtighten.
- Ensure the Hex Key is removed and the arbor lock has released before proceeding.
- Ensure the blade guard is fully functional before using the machine.

CHECKING AND ADJUSTING OF THE PRECISION ANGLES

Note: This machine has been accurately set up and adjusted at the factory. If it is suspected that some of the precision angles have been lost (due perhaps to normal workshop attrition) they can be reset by following the procedure outlined below.

Note: Several checks/adjustments are possible on this machine. The operator will require a set square (not supplied) to carry out these checks and adjustments.

WARNING: Checks/adjustments must only be conducted with the machine disconnected from the power supply.

BEVEL ANGLES (0° & 45°)

0° Bevel Stop Adjustment

Ensure that the cutting head is in the locked down position with the latching pin fully engaged in its socket.

Ensure that the cutting head is upright,

against its stop and the bevel pointer is indicating 0° on the scale. (Fig. 23)

Place the set square on the table with one edge against the table and the other edge against the blade (avoiding the TCT tips). (Fig. 24)

If the blade is not at 90 degrees (square) with the rotary table, then adjustment may be required.

- Loosen the bevel lock handle and tilt the cutting head to the left.
- Loosen the locknut on the Bevel Angle adjustment screw. (Fig. 25)
- Use a Hex Key to turn the screw in or out to adjust the blade angle.
- Return the cutting head to its upright position and recheck the angular alignment against the set square.
- Repeat the above steps until correct angular alignment is achieved.
- Tighten the Bevel Angle Adjustment locknut securely.

0° Bevel Pointer Adjustment

Note: The operator must be satisfied that the blade is set exactly perpendicular to the table when in the upright position and against its stop.

- If the pointer is not in exact alignment with the 0° mark on the protractor scale adjustment is necessary.
- Loosen the Bevel Pointer screw using a #2 Phillips screwdriver. (Fig. 26)
- Adjust the Bevel Pointer so that it is in alignment exactly with the 0° mark.
- Retighten the screw.

45° Bevel Stop Adjustment

- Loosen the bevel lock handle and tilt the cutting head completely to the left until it rests against the 45° stop.
- Use a set square to see if it is at 45 degrees to the Rotary table (avoid the TCT tips).
- If the saw blade is not in exact alignment adjustment is necessary.
- Return the cutting head to its upright position.

- Loosen the locknut on the 45° Bevel adjustment screw.
- Use a Hex Key to adjust the adjustment screw in or out as required. **(Fig. 27)**
- Tilt the cutting head to the 45° setting and recheck for alignment with the set square.
- Repeat the above steps until the correct angular alignment is achieved.
- Tighten the adjustment screw locknut securely once alignment is achieved.

THE DEPTH STOP **(Fig. 28)**

Use of the depth stop allows the operator to cut slots in a work-piece.

The downward travel of the cutting head can be limited so that the saw blade does not completely cut through the work-piece.

Note: When using the depth stop it is advisable that the depth of cut is checked using a scrap piece of timber to ensure that the slot is cut correctly.

By making a cut in the work-piece, and then repeating the cut but with the work-piece slightly repositioned to the left or right, it is possible to perform trenching cuts.

To use the depth stop:

- Deploy the depth stop 'stop plate' **(Fig. 28a)** by rotating it forward from its storage position alongside the machine through approximately 150 degrees to its service position.
- Loosen the knurled locking nut. **(Fig. 28b)**
- Adjust the thumb - screw **(Fig. 28c)** to limit the cutting heads travel to the required depth.
- Once set to the desired depth, tighten the knurled locking nut **(Fig.28b)** against the retaining bracket to lock the depth stop and ensure that there is no movement.
- When cutting is complete either re-adjust the depth stop or return the 'stop plate' to its storage position.
- Check that the Cutting can be locked in the down position by the head latching pin.

THE SLIDING UPPER FENCE SECTION **(Fig. 29)**

The Left Hand side of the machines Fence has an adjustable Upper section. This section can slide to the left by a maximum of approximately 100mm.

Note: To prevent the Sliding Upper section from being removed completely (and thus possibly being lost) the Sliding Upper section is 'captive' on the Lower Fence.

Adjustment may be necessary when certain acute bevel or compound angles are selected to provide clearance for the moving cutting head and blade as a cut is made.

To adjust the sliding fence:

- Loosen the thumbscrew. **(Fig. 30)**
- Slide the upper section of the Fence leftwards to the required position and tighten the thumbscrew.
- Conduct a 'dry run' with the power off to confirm that there is no interference between moving parts as the cutting head and blade are lowered to make a sliding cut.

MACHINE FENCE ALIGNMENT

The Fence must be aligned at 90° (square) to a correctly installed blade. The Rotary table must be set at '0°' mitre angle.

The Fence is fastened to the table with three **(3)** socket head Hex screws **(Fig. 31)**, one **(1)** to the left hand side and two **(2)** to the right hand side. All three **(3)** are located through elongated slots machined into the fence casting.

- Ensure that the cutting head is in the locked down position with the latching pin fully engaged.
- Place a set square on the table with one edge against the Fence and the other edge against the Blade (avoiding the TCT tips). **(Fig. 32)**
- If adjustment is necessary, loosen the three **(3)** Fence adjustment screws using a Hex Key.
- Re-position the Fence in its elongated slots until alignment is achieved.
- Securely tighten the socket head Hex screws.

Mitre Angle Pointer Adjustment

Note: There are dual mitre angle scales cast into the front of the machine's base. A small pointer attached to the rotary table indicates the angle selected.

If necessary, the pointer can be repositioned by loosening its fastening screw using a #2 Phillips screwdriver. Adjust as necessary, and then securely tighten the fixing screw. (Fig. 33)

THE LASER

This machine is equipped with a laser cutting guide. This allows the operator to preview the path of the blade through the work-piece. The ON/OFF switch for the laser Guide is positioned on the top of the cutting head near the mains cable entry point. (Fig. 40)

Avoid direct eye contact with the laser beam, and do not use on material that could reflect the laser beam.

WARNING: Do not stare directly at the laser beam. A hazard may exist if you deliberately stare into the beam. Please observe all of the following safety rules.

- The laser beam must not be deliberately aimed at personnel and must be prevented from being directed towards the eyes of a person.
- Always ensure that the laser beam is used only on work-pieces that have non-reflective surfaces, i.e. natural wood or matt surfaces etc.
- Never exchange the laser module assembly for a different type or class of laser.
- Repairs to the laser module must only be conducted by Evolution Power Tools or their authorized agent.

Note: The laser Guide can be a very useful facility, particularly when a large number of work-pieces are to be cut.

However the laser Guide should not be regarded as a substitute for good conventional planning and marking out.

LASER SAFETY

The laser guide line used in this product uses a class 2 laser with a maximum power output of 1mW at a wave length of between 650nm. These lasers do not normally present an

optical hazard, although staring at the beam may cause temporary flash blindness.

WARNING: Do not stare directly at the laser beam. The laser must be used and maintained as detailed in this manual. Never intentionally aim the laser beam at any person and prevent it from being directed towards the eye, or an object other than the work-piece. Always ensure that the laser beam is directed at the work-piece only when it is located on the mitre saw table.

Never direct the laser beam onto any bright, shiny reflective surface, as the laser beam could be reflected back towards the operator. Do not change the laser unit for any other type.

Do not tamper with the laser unit. Only touch the unit when making adjustments. Repairs to the laser shall only be carried out by an authorised service centre.

The laser guide line.

The projected laser guide line shows the path of the blade during a cut. To use the laser guide for a known angle (e.g. 45° mitre):

- Mark the cut required on the work-piece using a pencil, etc.
- Set the saw to the cutting angle required (45°) and lock into position using the mitre locking handle and/or the positive stop locking lever.
- Switch on the laser beam.
- Position the work-piece on the rotary table and against the fence.
- Slide the work-piece into position until the pencil line on the work-piece and the projected laser line exactly match.
- Clamp the work-piece into position using the hold down clamp.
- Proceed to make the cut.

To use the laser guide for an unknown angle:

- Mark the position of the cut to be made on the work-piece using a pencil etc.
- Place the work-piece on the rotary table and against the fence.

- Adjust the mitre saw to give the approximate angle of cut. Do not tighten the mitre lock handle at this stage.
- Slowly slide the work-piece backwards and forwards along the fence, whilst at the same time slowly adjusting the angle of the rotary table.
- Stop when the projected laser line and pencil line on the work-piece match exactly.
- Tighten the mitre lock handle to lock the rotary table in place.
- Secure the work-piece with a hold down clamp.
- Recheck the alignment.
- When satisfied that alignment is accurate proceed to make the cut.

The laser lens cap (if fitted)

If fitted the laser lens cap is a simple push fit onto the front of the laser unit.

If it becomes damaged or opaque for any reason it can be replaced.

Carefully pull the lens from the laser unit and replace with a new lens.

LASER ADJUSTMENT

WARNING: At no time during this procedure should the motor be started.

To check laser alignment:

- Place a piece of cardboard, or similar, onto the rotary table of the machine.
- With the carriage slide in the rearmost position, lower the cutting head so that a blade tooth makes a mark in the cardboard.
- Allow the cutting head to rise, and then repeat the above with the carriage slide in an approximate mid- way position.
- Again repeat, but with the carriage slide moved to its most forward position.
- With the cutting head raised, turn on the laser and slide the cutting head backwards and forwards to observe if the projected laser beam is in line with the marks previously made:
- Beam is aligned with the marks = No further action required.
- Beam is not parallel with the marks = Follow section A

- Beam is parallel but not aligned with the marks = Proceed to section B

A. If the laser beam is not parallel to the marks proceed as follows:

- Loosen the clamping screw. (**Fig.41a**)
- Carefully rotate the laser module, until the line is parallel with the marks in the cardboard.
- Re-tighten the clamping screw.
- Recheck the alignment.

B. If the laser beam is parallel with the marks, but not going through them:

- Slacken the two screws. (**Fig. 41b**)
- The laser mounting block can now be moved sideways to align the laser beam with the marks made in the cardboard.
- When the laser beam is in the correct place, re-tighten the two screws.
- Repeat procedure 'A' to check alignment.

Note: The above adjustments & alignments should be checked on a regular basis to ensure laser accuracy.

Note: The following WARNING labels can be found on this machine:

LASER RADIATION

DO NOT STARE INTO THE BEAM

CLASS 2 LASER PRODUCT

LASER RADIATION

AVOID DIRECT EYE CONTACT

PERMANENTLY MOUNTING THE MITRE SAW

To reduce the risk of injury from unexpected saw movement, place the saw in the desired location either on a workbench or other suitable machine stand. The base of the saw has four mounting holes through which suitable bolts (not supplied) can be placed to secure the mitre saw. If the saw is to be used in one location, permanently fasten it to the workbench using appropriate fastenings (not supplied). Use locking washers and nuts on the underside of the workbench. (**Fig. 43**)

- To avoid injury from flying debris, position the saw so that other people or bystanders cannot stand too close (or behind) it.
- Locate the saw on a firm, level surface where

there is plenty of room for handling and properly supporting the work-piece.

- Support the saw so the machine table is level and the saw does not rock.
- Bolt or clamp the saw securely to its support stand or workbench.

Note: This machine can be attached to the Evolution Mitre Saw Stand. (Fig. 44). This will provide a safe secure, and extremely portable workshop stand which is capable of handling long pieces of material. Operator efficiency and safety may thus be enhanced, as well as operator fatigue reduced.

FOR PORTABLE USE:

- Mount the saw on a 18mm thick piece of plywood or MDF (800mm x 500mm min size recommended) using appropriate fastenings (not supplied).

Note: It may be necessary to countersink the washers, nuts, etc. to the underside of the plywood or MDF mounting board. The underside needs to be smooth and flush with no protruding fixings etc.

- Use 'G' clamps to attach the mounting board to the work surface. (Fig. 45)

THE HOLD DOWN CLAMP (Fig. 46)

Note: One (1) Hold Down Clamp is provided with the machine.

Two sockets (one either side) are incorporated into the rear of the machines Fence. These sockets are for positioning the Hold Down Clamp.

To use the Hold Down Clamp during operations:

- Fit the clamp to the retaining socket that best suits the cutting application, ensuring that it is fully pushed down.
- Tighten the fence thumbscrew to lock the pillar of the clamp into the fence socket.
- Place the work-piece to be cut onto the saw table, against the Fence and in the desired position.
- Adjust the clamp using the thumbscrews and hand-wheel so that it securely holds the work-piece to the saw table.

Conduct a 'dry run' with the power disconnected. Ensure that the Hold Down Clamp does not interfere with the path of the blade, or with the path of any other part of the cutting head as it is lowered to make the cut.

Note: The R210SMS includes the 2 piece clamp. The R210SMS+ includes 3 piece clamp.

Front Clamp (Included with R210SMS+)

To fit the front clamp, place the rear of the clamp into the holes at the front of the saw's base. There are holes for the clamp located on both left and right of the base. (Fig. 31)

OPERATING INSTRUCTIONS

Caution: All mitre saws should be inspected (particularly for the correct functioning of the safety guards) before each use. Do not connect the saw to the power supply until a safety inspection has been carried out.

WARNING: Ensure that the operator is adequately trained in the use, adjustment and maintenance of this machine, before connecting it to the power supply and commencing operations. To reduce the risk of injury, always unplug the saw before changing or adjusting any of the machines parts. Compare the direction of the rotation arrow on the guard to the direction arrow on the blade. The blade teeth should always point downward at the front of the saw. Check the tightness of the arbor screw.

(8.3) BODY & HAND POSITIONING (Fig. 47)

- Never place your hands within the 'no hands zone' (at least 150mm away from the blade).
- Keep hands away from the path of the blade.
- Secure the work-piece firmly to the table and against the fence to prevent any movement.
- Use a Hold Down Clamp if possible but check that it is so positioned that it does not interfere with the path of the blade or other moving machine parts.
- Avoid awkward operations and hand positions where a sudden slip could cause your fingers or a hand to move into the blade.
- Before attempting a cut, make a 'dry run' with the power off so that you can see the path of the blade.

- Keep your hands in position until the ON/OFF trigger switch has been released and the blade has completely stopped.

THE ON/OFF TRIGGER SWITCH (Fig. 48)

The ON/OFF motor trigger switch is a non-latching type. It is ergonomically positioned inside the Cutting HANDLE.

To start the motor:

- Press the switch to start the motor.
- Release the switch to turn off the motor.

Place the saw on a secure stationary work surface and check the saw over carefully.

Check particularly the operation of all the machines safety features before attempting to operate the machine.

PREPARING TO MAKE A CUT DO NOT OVER-REACH

Keep good footing and balance. Stand to one side so that your face and body are out of line of a possible kickback.

WARNING: Freehand cutting is a major cause of accidents and should not be attempted.

- Ensure that the work-piece is always firmly resting against the fence, and where practical is clamped with the Hold Down Clamp to the table.
- The saw table should be clean and free from any sawdust etc. before the work-piece is clamped into position.
- Ensure that the 'cut-off' material is free to move sideways away from the blade when the cut is completed. Ensure that the 'cut-off' piece cannot become 'jammed' in any other part of the machine.
- Do not use this saw to cut small pieces. If the work-piece being cut would cause your hand or fingers to be within 150mm of the saw blade, the work-piece is too small.

CHOP CUTTING

This type of cut is used mainly for cutting small or narrow section material. The cutting head is gently pushed down to cut through the work-piece. The sliding carriage should be locked in its rearmost position. (Fig. 49)

- Slide the cutting head to the rear as far as it will go.
- Tighten the slide lock screw. (Fig. 50)
- Place the work-piece on the table and against the fence and secure with clamp(s) as appropriate.
- Grasp the Cutting Handle.
- Turn the motor on and allow the saw blade to reach full speed.
- Press the lower guard locking trigger to release the cutting head. (Fig. 51)
- Lower the Cutting Handle downwards and cut through the work-piece.
- Allow the speed of the blade to do the work, there is no need to apply undue pressure to the Cutting Handle.
- When the cut has been completed, release the ON/OFF trigger switch.
- Allow the blade to come to a complete stop.
- Allow the cutting head to rise to its upper position, with the lower blade guard completely covering the blade teeth, and the cutting head locked in the upper position, before releasing the Cutting Handle.
- Remove the work-piece.

SLIDE CUTTING

This saw is equipped with a sliding carriage system.

Loosening the slide lock screw will release the slide and allow the cutting head to move forwards and backwards. (Fig. 52)

The saw blade is lowered into the work-piece and then pushed to the rear of the machine to complete a cut. This type of cut can be used for cutting wide pieces.

- Position the work-piece on the table and against the fence and secure with clamp(s) as appropriate.
- Loosen the slide lock screw.
- Grasp the Cutting Handle and pull the cutting head forward until the arbor (centre of saw blade) is over the front edge of the work-piece. (Fig. 53)
- Operate the ON/OFF motor trigger switch and allow the saw blade to reach full speed.
- Press the lower blade guard locking trigger for cutting head release.

- Push the Cutting Handle all the way down and cut through the leading edge of the work-piece.
- Gently push the cutting handle rearwards towards the fence completing the cut.
- Always push the cutting head to the full rear position during each cut. **(Fig. 54)**
- When the cut has been completed, release the trigger switch and allow the blade to come to a complete stop.
- Allow the cutting head to rise to its upper position, with the lower blade guard completely covering the blade teeth, and the cutting head locked in the upper position, before releasing the Cutting Handle.

WARNING: Never pull the cutting head and spinning blade towards you when making a sliding cut. The blade may try to climb up on top of the work-piece, causing the cutting head to 'Kickback' forcefully.

The cutting head should always be positioned as outlined above before attempting to make a sliding cut. When the cutting head is in the correct position above the work-piece it can be lowered and pushed rearwards towards the fence to complete the cut.

MITRE CUTTING (Fig. 58)

The rotary table of this machine can be turned through 50° to the left or right from the normal cross-cut (0°) position.

Positive stops are provided at 45°, 30°, 22.5° and 15° to both the right hand and left hand sides. Mitre Cutting is possible with or without the sliding carriage system being deployed.

- Loosen the mitre handle locking knob **(Fig. 56)** by turning the locking knob anti-clockwise.
- Pull up the positive stop locking lever. **(Fig. 57)**
- Turn the rotary table to the desired angle.

Note: A protractor scale is incorporated into the machines base to aid setting.

- Tighten the mitre handle locking knob when the angle is achieved.

Note: It is good practice to tighten the Mitre Locking Knob even when a positive stop is selected and the Positive Stop Locking Lever is

positively engaged.

BEVEL CUTTING BY TILTING THE CUTTING HEAD

A bevel cut **(Fig. 55)** is made with the rotary table set at 0° mitre angle.

Note: It may be necessary to adjust the upper section of the sliding fence to provide clearance for the moving cutting head. **(Fig. 29-30)**

The cutting head can be tilted from the normal 0° (perpendicular position) to a maximum angle of 45° from the perpendicular to the left hand side only. Bevel cutting is possible with or without the sliding carriage system being deployed.

Note: A positive stop is provided at 33.9° Bevel angle. This is accessed by deploying (pushing inwards) the 33.9° Bevel Pin. **(Fig. 59)** Normally the Bevel Pin should be left in the un-deployed (pulled out) position.

To tilt the cutting head to the left:

- Loosen the bevel lock handle. **(Fig. 60)**
- Tilt the cutting head to the required angle. A protractor scale is provided as an aid to setting. **(Fig 61)**
- Tighten the bevel lock handle when the desired angle has been selected.
- Stand to the left side of the Cutting Handle when making a cut.

When cutting is completed:

- Release the ON/OFF trigger switch to switch off the motor, but keep your hands in position.
- Allow the blade to come to a complete stop.
- Allow the cutting head has to rise to its upper position, with the lower blade guard completely deployed and covering the blade before removing yours hand(s).
- Return the cutting head to the perpendicular position.

COMPOUND CUTTING (Fig. 62)

A compound cut is a combination of a mitre and bevel cut employed simultaneously. When a compound cut is required, select the desired bevel and mitre positions as previously described.

Note: Compound Cutting with the sliding

carriage system deployed is possible. Always check that the sliding blade does not interfere with the machines fence or any other parts of the machine. Adjust the upper left hand section of the sliding fence if necessary.

CROWN MOULDING CUTTING

This machine is capable of cutting the mitre angles required for Crown Mouldings. To configure the machine to cut Crown Moulding:

- Deploy the 33.9° Bevel Pin by pushing it fully inwards. (Fig. 59)
- Tilt the cutting head to the 33.9° position and lock it in place by tightening the bevel lock handle.
- Turn the rotary table and set it to 31.6° mitre angle as indicated by the protractor scale.

Ensure that the Crown Moulding is correctly positioned on the rotary table and secure it with appropriate clamps before making the cut.

When cutting operations are completed, return the cutting head to the vertical position and return the 33.9° Bevel Pin to its outer (disengaged) position.

CUTTING BOWED MATERIAL (Fig. 63)

WARNING: Before cutting any work-piece, check to see if it is bowed. If it is bowed the work-piece must be positioned and cut as shown. Do not position the work-piece incorrectly or cut the work-piece without the support of the Fence.

CLEARING JAMMED MATERIAL

- Turn mitre saw "OFF" by releasing the trigger switch.
- Allow the blade to come to a complete halt.
- Unplug the mitre saw from the mains supply.
- Carefully remove any jammed material from the machine.
- Check the condition and operation of the safety guard.
- Check for any other damage to any part of the machine e.g. the blade.
- Have any damaged parts replaced by a competent technician and a safety inspection carried out before using the machine again.

The free end of a long work-piece should be supported at the same height as the machines rotary table. The operator should consider using a remote work-piece support stand, adjustable workmate or saw horse etc.

OPTIONAL EVOLUTION ACCESSORIES

DUST BAG (Supplied with R210SMS+)

A Dust Bag can be fitted to the extraction port at the rear of the machine. The Dust Bag is for use when cutting wooden materials only.

- Slide the Dust Bag over the dust extraction port, ensuring that the spring clip grips the port holding the Dust Bag securely in place. (Fig. 64)

Note: For operational efficiency empty the Dust Bag when it becomes 2/3 full. Dispose of the contents of the Dust Bag in an environmentally responsible way. It may be necessary to wear a dust mask when emptying the Dust Bag.

Note: A workshop vacuum extraction machine can be attached to the dust extraction port if required. Follow the manufacturers instructions if such a machine is fitted.

WARNING: Do not use the Dust Bag when cutting metallic materials including wood with nails.

EXTRACTION PORT ADAPTOR

TUBE (Supplied with R210SMS+)

Use the Adaptor Tube to connect the extraction port of the machine to suitable commercial workshop vacuum extraction equipment (not supplied) which have ø30mm internal bore hoses or inlet ports.

ASSEMBLY SAFETY CHECKS

PART	CONDITION	YES
Slides	Inserted through the bevel neck and connected to the cutting head. Locating lugs successfully deployed.	
Mitre Handle Locking Knob	Installed into mitre handle / rotary table	
Slide Carriage locking screw	Inserted into the threaded hole in the bevel neck. Anti-vibration spring fitted beneath the locking screw hand knob.	
Power Cable	Routed correctly with cable guide/clamps correctly installed.	
Blade	Blade correctly installed and with the rotation arrows on the blade and on the machine matching. Outer blade flange and arbor bolt and washer correctly fitted.	
Safety Guards	Lower Safety Guard fully operational. cutting head locks in the upper position with blade covered. cutting head can only be lowered when Blade Guard Locking Lever is operated.	
Supply	Supply matches specification found on machine Rating Plate. Plug matches power source outlet.	
Mounting	Either: a) Machine permanently sited and bolted to workbench. b) Machine mounted on board which can be clamped to workbench. c) Machine is bolted to a dedicated mitre saw Stand.	
Sited	Adequate provision made for the handling of long or irregular shaped work-pieces.	
Environment	Dry, clean and tidy. Temperature conducive to material handling. Lighting adequate. (double banked if fluorescent lights are used)	

All the Yes Boxes must be ticked before the machine can be used. No tick = No use.

FINAL SAFETY CHECKS

PART	CONDITION	YES
Assembly	Repeat the Assembly Safety Checks.	
Operation	With the machine switched off and disconnected from the mains supply, carry out the following procedures: <ul style="list-style-type: none"> • Set the machine to each of its maximum operational settings in turn. • At each setting lower the cutting head to its lowest position, observing the path of the blade as you do so. • Check that the blade does not interfere or strike any part of the machine, castings or guards as the cutting head is lowered. • Check that when the sliding carriage is employed no contact between the cutting head and the blade and other parts of the machine occurs. • Spin the blade by hand (it is advisable to wear gloves whilst doing this, but not when the saw is being used operationally). • Check that the blade rotates smoothly with no unusual noises, and that there is no contact between the blade and the upper and lower blade guards. • Check that there is no discernible blade 'wobble' in any direction as the blade rotates. 	

All the Yes Boxes must be ticked before the machine can be used. No tick = No use.

MAINTENANCE

Note: Any maintenance must be carried out with the machine switched off and disconnected from the mains/battery power supply.

Check that all safety features and guards operating correctly on a regular basis. Only use this machine if all guards/safety features are fully operational.

All motor bearings in this machine are lubricated for life. No further lubrication is required.

Use a clean, slightly damp cloth to clean the plastic parts of the machine. Do not use solvents or similar products which could damage the plastic parts.

WARNING: Do not attempt to clean by inserting pointed objects through openings in the machines casings etc. The machines air vents should be cleaned using compressed dry air.

Excessive sparking may indicate the presence of dirt in the motor or worn out carbon brushes. If this is suspected have the machine serviced and the brushes replaced by a qualified technician.

(6.4) ENVIRONMENTAL PROTECTION

Waste electrical products should not be disposed of with household waste. Please recycle where facilities exist. Check with your Local Authority or retailer for recycling advice.



EC DECLARATION OF CONFORMITY

The manufacturer of the product covered by this Declaration is:

Evolution Power Tools, Venture One, Longacre Close, Holbrook Industrial Estate, Sheffield, S20 3FR.

The manufacturer hereby declares that the machine as detailed in this declaration fulfils all the relevant provisions of the Machinery Directive and other appropriate directives as detailed below. The manufacture further declares that the machine as detailed in this declaration, where applicable, fulfils the relevant provisions of the Essential Health and Safety requirements.

The Directives covered by this Declaration are as detailed below:

2006/42/EC	Machinery Directive.
2014/30/EU.	Electromagnetic Compatibility Directive,
2011/65/EU.	The Restriction of the Use of certain Hazardous Substances in Electrical Equipment (RoHS) Directive
2012/19/EU.	The Waste Electrical and Electronic Equipment (WEEE) Directive.

And is in conformity with the applicable requirements of the following documents

**EN 62841-1:2015 • EN 62841-3-9:2015 • EN ISO 12100:2010 • AfPS GS 2014:01 PAK
EN 55014-2: 2015 • EN 61000-3-3: 2013 • EN 55014-1:2006/A2:2011
EN 61000-3-2:2014**

Product Details

Description: R210SMS 210mm MULTI-MATERIAL SLIDING MITRE SAW
 Evolution Model No: R210SMS: 048-0001 / 048-0001A / 048-0001B / 046-0002
 046-0002A / 046-0002B / 048-0003 / 048-0003A / 048-0003B
 Brand Name: EVOLUTION
 Voltage: 220-240V / 110V ~ 50 Hz
 Input: 1500W

The technical documentation required to demonstrate that the product meets the requirements of directive has been compiled and is available for inspection by the relevant enforcement authorities, and verifies that our technical file contains the documents listed above and that they are the correct standards for the product as detailed above.

Name and address of technical documentation holder.



Signed:

Print: Barry Bloomer
Supply Chain & Procurement Director

Date:

29/08/2017

Evolution Power Tools, Venture One, Longacre Close, Holbrook Industrial Estate, Sheffield S20 3FR

evOLUTION®

evolutionpowertools.com

UK

Evolution Power Tools Ltd
Venture One
Longacre Close
Holbrook Industrial Estate
Sheffield
S20 3FR

+44 (0)114 251 1022

US

Evolution Power Tools LLC
8363 Research Drive
Davenport
Iowa
52806

+1 866-EVO-TOOL

EU

Evolution Power Tools SAS
61 Avenue Lafontaine
33560
Carbon-Blanc
Bordeaux

+ 33 (0)5 57 30 61 89



EPT QR CODE