

# evOLUTION®

evolutionpowertools.com

Original Instructions  
Originalbetriebsanleitung  
Notice Originale

Instrucciones Originales  
Oryginalna Instrukcja  
Instruções Originais

Instrucțiuni Inițiale  
Оригинальные Инструкции  
Original Talimatlar

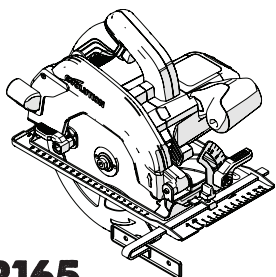

**R165**

**CCSL**

026-0001,  
026-0002,  
026-0003

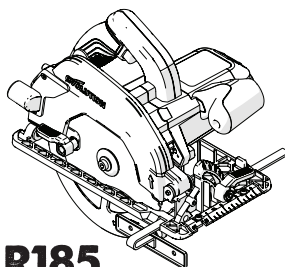

**R185**

**CCS**

027-0001C, 027-0002C,  
027-0003C, 027-0004C,  
027-0006, 027-0010

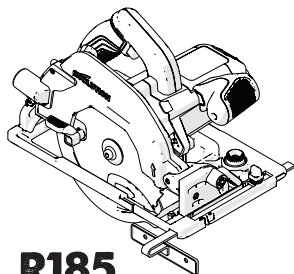

**R185**

**CCSX**

027-0001,  
027-0002,  
027-0003

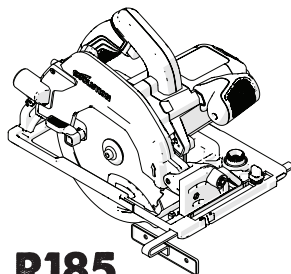

**R185**

**CCSX+**

027-0001A, 027-0002A,  
027-0003A, 027-0004A,  
027-0006A



GB2438285

## TABLE OF CONTENTS

<b>INTRODUCTION</b>		<b>MAINTENANCE &amp; ADJUSTMENTS</b>	Page 28
Warranty	Page 3	Checking & Replacing Carbon Brushes	Page 29
Specifications	Page 4	General Maintenance & Cleaning	Page 29
Items Supplied	Page 4	Environmental Protection	Page 29
Vibration	Page 4		
Labels And Symbols	Page 6	<b>DECLARATION OF CONFORMITY</b>	<b>Page 30</b>
Intended Use Of This Power Tool	Page 7		
Prohibited Use Of This Power Tool	Page 7		
<b>SAFETY PRECAUTIONS</b>			
Electrical Safety	Page 7		
Outdoor Use	Page 7		
General Power Tool Safety Instructions	Page 7		
Health Advice	Page 9		
Safety Instructions For All Saws	Page 9		
Additional Safety Instructions For Circular Saws	Page 11		
<b>GETTING STARTED</b>			
Unpacking	Page 11		
Machine Overview	Page 12		
Preparation	Page 21		
Installing/Removing A Blade	Page 21		
Parallel Edge Guide	Page 22		
Cutting Depth Adjustment	Page 22		
Cutting Angle Adjustment	Page 22		
Operating Advice (Pre Operation Checks)	Page 22		
PPE	Page 23		
The On/Off Trigger Switch	Page 23		
Cutting Tracks	Page 24		
<b>ADDITIONAL ADVICE</b>			
Debris Collection Port	Page 26		
Led Light	Page 26		
Specialised Adjustments	Page 27		
General Cutting Advice	Page 27		
Cut Material Ejection Port	Page 28		

(1.2) **INTRODUCTION**  
**IMPORTANT**

Please read these operating and safety instructions carefully and completely.

For your own safety, if you are uncertain about any aspect of using this equipment please access the relevant Technical Helpline, the number of which can be found on the Evolution Power Tools website. We operate several Helplines throughout our worldwide organization, but Technical help is also available from your supplier.

(1.3) **CONTACT:**

**Web:** [www.evolutionpowertools.com](http://www.evolutionpowertools.com)

**UK/EU/AUS:** [customer.services@evolutionpowertools.com](mailto:customer.services@evolutionpowertools.com)

**USA:** [evolutioninfo@evolutionpowertools.com](mailto:evolutioninfo@evolutionpowertools.com)

(1.4) **WARRANTY**

Congratulations on your purchase of an Evolution Power Tools Machine. Please complete your product registration 'online' as explained in the registration leaflet included with this machine. This will enable you to validate your machine's warranty period via Evolutions website by entering your details and thus ensure prompt service if ever needed.

We sincerely thank you for selecting a product from Evolution Power Tools.

## SPECIFICATIONS

MACHINE SPECIFICATIONS	USA		
	R185CCS	R185CCSX	R185CCSX+
Model No:	027-0004	027-0004C	027-0004A
Motor EU (220-240V ~ 50 Hz)			
Motor UK (110V ~ 50 Hz)			
Motor USA (120V ~ 60 Hz)	15A	15A	15A
No-Load Speed (220-240v)			
No-Load Speed (110v & 120v)	3700 min <sup>-1</sup> / rpm	3700 min <sup>-1</sup> / rpm	3700 min <sup>-1</sup> / rpm
Weight	10.8 lb	11.2 lb	11.2 lb
Max. Blade Bevel Angle (Degrees)	60°	45°	45°
Power Cable Length	13 ft	13 ft	13 ft
Circular Saw Base Type	Cast Aluminum	Cast Aluminum	Cast Aluminum
Cutting Track Compatible		✓	✓

CUTTING CAPACITIES	R185CCS	R185CCSX	R185CCSX+
Mild Steel Plate (Max. Thickness)	1/4"	1/4"	1/4"
Mild Steel Box Section (Max. Wall)	1/4"	1/4"	1/4"
Max. Cutting Thickness (0°)	2-1/2"	2-1/2" (2-5/16" w/Track)	2-1/2" (2-5/16" w/Track)
Max. Cutting Thickness (45°)	1-9/16"	1-13/16" (1-5/8" w/Track)	1-13/16" (1-5/8" w/Track)
Max. Cutting Thickness (60°)	1"		

BLADE SPECIFICATIONS	R185CCS	R185CCSX	R185CCSX+
Blade Diameter	Ø 7-1/4"	Ø 7-1/4"	Ø 7-1/4"
Number of Teeth	16	16	16
Bore Diameter	25/32"	25/32"	25/32"
Kerf	1.7mm	1.7mm	1.7mm

NOISE & VIBRATION DATA	R185CCS	R185CCSX	R185CCSX+
Sound Pressure Level L <sub>ps</sub>	94,3dB(A) K=3 dB(A)	94,3dB(A) K=3 dB(A)	94,3dB(A) K=3 dB(A)
Sound Power Level L <sub>wa</sub>	105,3dB(A) K=3 dB(A)	105,3dB(A) K=3 dB(A)	105,3dB(A) K=3 dB(A)
Vibration - Main Handle (Sawing Wood)	A <sub>h,w</sub> = 3,347m/s <sup>2</sup>	a <sub>h,w</sub> = 3,347m/s <sup>2</sup>	a <sub>h,w</sub> = 3,347m/s <sup>2</sup>
Vibration - Auxiliary Handle (Sawing Wood)	A <sub>h,w</sub> = 3,119m/s <sup>2</sup>	a <sub>h,w</sub> = 3,119m/s <sup>2</sup>	a <sub>h,w</sub> = 3,119m/s <sup>2</sup>
Vibration - Main Handle (Sawing Metal)	a <sub>h,m</sub> = 3,572m/s <sup>2</sup>	a <sub>h,m</sub> = 3,572m/s <sup>2</sup>	a <sub>h,m</sub> = 3,572m/s <sup>2</sup>
Vibration - Auxiliary Handle (Sawing Metal)	a <sub>h,m</sub> = 3,241m/s <sup>2</sup>	a <sub>h,m</sub> = 3,241m/s <sup>2</sup>	a <sub>h,m</sub> = 3,241m/s <sup>2</sup>
Uncertainty K	1,5m/s <sup>2</sup>	1,5m/s <sup>2</sup>	1,5m/s <sup>2</sup>

ITEMS SUPPLIED	R185CCS	R185CCSX	R185CCSX+
Multi-Material TCT Blade	✓	✓	✓
Hex Key (Blade Change)	✓	✓	✓
Parallel Edge Guide	✓	✓	✓
Dust Port Adapter	✓	✓	✓
Dust Hose Connector	✓	✓	✓
Carry Case			✓
Cutting Track - 340mm (13-3/8") x3		✓	
Connector Bar & Screws (x4)		✓	
LED Light	✓		✓

UK / EU / AUS			
R165CCSL	R185CCS	R185CCSX	R185CCSX+
026-0001 / 026-0002 / 026-0003	027-0001C / 027-0002C / 027-0003C	027-0001 / 027-0002 / 027-0003	027-0001A / 027-0002A / 027-0003A
1200W	1600W	1600W	1600W
1200W	1600W	1600W	1600W
3700 min <sup>-1</sup> / rpm	3900 min <sup>-1</sup> / rpm	3900 min <sup>-1</sup> / rpm	3900 min <sup>-1</sup> / rpm
3700 min <sup>-1</sup> / rpm	3700 min <sup>-1</sup> / rpm	3700 min <sup>-1</sup> / rpm	3700 min <sup>-1</sup> / rpm
4.3 kg	4.9 kg	5.1 kg	5.1 kg
45°	60°	45°	45°
3m	3m	3m	4m
Pressed Steel	Cast Aluminium	Cast Aluminium	Cast Aluminium
		✓	✓

R165CCSL	R185CCS	R185CCSX	R185CCSX+
3mm	6mm	3mm	6mm
3mm	6mm	3mm	6mm
53mm	64mm	64mm (59mm w/Track)	64mm (59mm w/Track)
34mm	40mm	47mm (42mm w/Track)	47mm (42mm w/Track)
	24mm		

R165CCSL	R185CCS	R185CCSX	R185CCSX+
∅ 165mm	∅ 185mm	∅ 185mm	∅ 185mm
14	20	16	20
20mm	20mm	20mm	20mm
1.7mm	1.7mm	1.7mm	1.7mm

R165CCSL	R185CCS	R185CCSX	R185CCSX+
92,4dB(A) K:3dB(A)	94,3dB(A) K=3 dB(A)	94,3dB(A) K=3 dB(A)	94,3dB(A) K=3 dB(A)
103,4dB(A) K:3dB(A)	105,3dB(A) K=3 dB(A)	105,3dB(A) K=3 dB(A)	105,3dB(A) K=3 dB(A)
$a_{h,w} = 2,747m/s^2$	$a_{h,w} = 3,347m/s^2$	$a_{h,w} = 3,347m/s^2$	$a_{h,w} = 3,347m/s^2$
$a_{h,w} = 2,619m/s^2$	$a_{h,w} = 3,119m/s^2$	$a_{h,w} = 3,119m/s^2$	$a_{h,w} = 3,119m/s^2$
$a_{h,M} = 2,302m/s^2$	$a_{h,M} = 3,572m/s^2$	$a_{h,M} = 3,572m/s^2$	$a_{h,M} = 3,572m/s^2$
$a_{h,M} = 2,239m/s^2$	$a_{h,M} = 3,241m/s^2$	$a_{h,M} = 3,241m/s^2$	$a_{h,M} = 3,241m/s^2$
1,5m/s <sup>2</sup>	1,5m/s <sup>2</sup>	1,5m/s <sup>2</sup>	1,5m/s <sup>2</sup>

R165CCSL	R185CCS	R185CCSX	R185CCSX+
✓	✓	✓	✓
✓	✓	✓	✓
✓	✓	✓	✓
✓	✓	✓	✓
✓	✓	✓	✓
		✓	✓
		✓	
			✓

**VIBRATION**

(1.5) **Note:** The vibration measurement was made under standard conditions in accordance with: EN 62841-1: 2015, EN 62841-2-5: 2014

**Warning: Wear hearing protection!**

The declared vibration total value has been measured in accordance with a standard test method and may be used for comparing one tool with another.

The declared vibration total value may also be used in a preliminary assessment of exposure.

(1.6) **WARNING:** When using this machine the operator can be exposed to high levels of vibration transmitted to the hand and arm. It is possible that the operator could develop "Vibration white finger disease" (Raynaud syndrome). This condition can reduce the sensitivity of the hand to temperature as well as producing general numbness. Prolonged or regular users of this machine should monitor the condition of their hands and fingers closely. If any of the symptoms become evident, seek immediate medical advice.

- The measurement and assessment of human exposure to hand-transmitted vibration in the workplace is given in: EN 62841-1 and EN 62841-2-5
- Many factors can influence the actual vibration level during operation e.g. the work surfaces condition and orientation and the type and condition of the machine being used. Before each use, such factors should be assessed, and where possible appropriate working practices adopted. Managing these factors can help reduce the effects of vibration:

**Handling**

- Handle the machine with care, allowing the machine to do the work.
- Avoid using excessive physical effort on any of the machines controls.
- Consider your security and stability, and the orientation of the machine during use.

**Work Surface**

- Consider the work surface material; its condition, density, strength, rigidity and orientation.

**WARNING:** The vibration emission during actual use of the power tool can differ from the declared total value depending on the ways in which the tool is used.



The need to identify safety measures and to protect the operator are based on an estimation of exposure in the actual conditions of use (taking account of all parts of the operating cycle, such as the times the tool is switched off, when it is running idle, in addition to trigger time).







(1.7) **LABELS & SYMBOLS**

**WARNING:** Do not operate this machine if warning and/or instruction labels are missing or damaged. Contact Evolution Power Tools for replacement labels.

**Note:** All or some of the following symbols may appear in the manual or on the product.

(1.8)

Symbol	Description
V	Volts
A	Amperes
Hz	Hertz
Min <sup>-1</sup> / RPM	Speed
~	Alternating Current
n <sub>0</sub>	No Load Speed
	Wear Safety Goggles
	Wear Ear Protection
	Wear Dust Protection

	Read Instructions
	Double Insulated
	CE Certification
	ETL Certification
	Waste Electrical & Electronic Equipment
	Triman - Waste Collection & Recycling
	Warning
	(RCM) Regulatory Compliance Mark for electrical and electronic equipment. Australian/New Zealand Standard 5490

### (1.9) INTENDED USE OF THIS POWER TOOL

**WARNING:** This product is a Hand Operated Circular Saw and has been designed to be used with special Evolution blades. Only use accessories designed for use in this machine and/or those recommended specifically by Evolution Power Tools Ltd.

When fitted with an appropriate blade this machine can be used to cut:

**Mild Steel, Aluminium, Wood**

**Note:** Cutting galvanised steel may reduce blade life.

### (1.10) PROHIBITED USE OF THIS POWER TOOL

**WARNING:** This product is a Hand Operated Circular Saw and must only be used as such. It must not be modified in any way, or used to power any other equipment or drive any other accessories other than those mentioned in this Instruction Manual.

(1.11) **WARNING:** This machine is not intended for use by persons (including children) with reduced physical, sensory or mental capabilities, or lack of experience and knowledge, unless they have been given supervision or instruction concerning the safe use of the machine by a person responsible for their safety and who is competent in its safe use.

Children should be supervised to ensure that they do not have access to, and are not allowed to play with, this machine.

### (1.12) ELECTRICAL SAFETY

This machine is fitted with the correct moulded plug and mains lead for the designated market. If the supply cord is damaged, it must be replaced by a special cord or assembly available from the manufacturers or its service agent.

### (1.13) OUTDOOR USE

**WARNING:** For your protection if this tool is to be used outdoors it should not be exposed to rain, or used in damp locations. Do not place the tool on damp surfaces. Use a clean, dry workbench if available. For added protection use a residual current device (R.C.D.) that will interrupt the supply if the leakage current to earth exceeds 30mA for 30ms. Always check the operation of the residual current device (R.C.D.) before using the machine.

If an extension cable is required it must be a suitable type for use outdoors and so labelled. The manufacturers instructions should be followed when using an extension cable.

### (2.1) GENERAL SAFETY INSTRUCTIONS

(These General Power Tool Safety Instructions are as specified in EN 62841-1: 2015).

**WARNING:** Read all safety warnings and instructions. Failure to follow the warnings and instructions may result in electric shock, fire and/ or serious injury. Save all warnings and instructions for future reference. The term "power tool" in

the warnings refers to your mains-operated (corded) power tool or battery-operated (cordless) power tool.

**(2.2) 1) General Power Tool**

**Safety Warnings [Work area safety]**

**a) Keep work area clean and well lit.** Cluttered or dark areas invite accidents.

**b) Do not operate power tools in explosive atmospheres, such as in the presence of flammable liquids, gasses or dust.** Power tools create sparks which may ignite the dust or fumes.

**c) Keep children and bystanders away while operating power tool.** Distractions can cause you to lose control.

**(2.3) 2) General Power Tool Safety Warnings [Electrical Safety]**

**a) Power tool plugs must match the outlet. Never modify the plug in any way. Do not use any adapter plugs with earthed (grounded) power tools.** Unmodified plugs and matching outlets will reduce risk of electric shock.

**b) Avoid body contact with earthed or grounded surfaces, such as pipes, radiators, ranges and refrigerators.** There is an increased risk of electric shock if your body is earthed or grounded.

**c) Do not expose power tools to rain or wet conditions.** Water entering a power tool will increase the risk of electric shock.

**d) Do not abuse the cord. Never use the cord for carrying, pulling or unplugging the power tool. Keep cord away from heat, oil, sharp edges or moving parts.** Damaged or entangled cords increase the risk of electric shock.

**e) When operating a power tool outdoors, use an extension cord suitable for outdoor use.** Use of a cord suitable for outdoor use reduces the risk of electric shock.

**f) If operating a power tool in a damp location is unavoidable, use a residual current device (RCD) protected supply.**

Use of an RCD reduces the risk of electric shock.

**Note:** The product is intended for use only in premises having a service current capacity  $\geq 100\text{A}$  per phase, supplied from a distribution network having a nominal voltage

of 230V. If required, contact the electricity company to ensure that the mains current carrying capacity at the connection point to the public power grid is adequate for connecting the product.

**(2.4) 3) General Power Tool Safety Warnings [Personal Safety].**

**a) Stay alert, watch what you are doing and use common sense when operating a power tool.** Do not use a power tool while you are tired or under the influence of drugs, alcohol or medication. A moment of inattention while operating power tools may result in serious personal injury.

**b) Use personal protective equipment.** Always wear eye protection. Protective equipment such as dust masks, non-skid safety shoes, hard hat or hearing protection used for appropriate conditions will reduce personal injuries.

**c) Prevent unintentional starting.** Ensure the switch is in the off-position before connecting to power source and/or battery pack, picking up or carrying the tool. Carrying power tools with your finger on the switch or energising the power tools that have the switch on invites accidents.

**d) Remove any adjusting key or wrench from blade bolt before turning the power tool on.** A wrench or key left attached to a rotating part of a power tool may result in personal injury.

**e) Do not overreach. Keep proper footing and balance at all times.** This enables better control of the power tool in unexpected situations.

**f) Dress properly.** Do not wear loose clothing or jewellery. Keep your hair, clothing and gloves away from moving parts. Loose clothes, jewellery or long hair can be caught in moving parts.

**g) If devices are provided for the connection of dust extraction and collection facilities, ensure that these are connected and properly used.** Use of dust collection can reduce dust-related hazards.

**h) Do not let familiarity gained from frequent use of tools allow you to become complacent and ignore tool safety principles.** A careless action can cause severe injury within a fraction of a second.



**(2.5) 4) General Power Tool Safety Warnings [Power tool use and care].**

**a) Do not force the power tool.** Use the correct power tool for your application. The correct power tool will do the job better and safer at a rate for which it was designed.

**b) Do not use the power tool if the switch does not turn it on or off.** Any power tool that cannot be controlled with the switch is dangerous and must be repaired.

**c) Disconnect the power tool from the power source from the power tool before making any adjustments, changing accessories, or storing power tools.** Such preventative safety measures reduce the risk of starting the power tool accidentally.

**d) Store idle power tools out of the reach of children and do not allow persons unfamiliar with the power tool or these instructions to operate the power tool.**

Power tools are dangerous in the hands of untrained users.

**e) Maintain power tools.** Check for misalignment or binding of moving parts, breakage of moving parts and any other condition that may affect the power tools operation. If damaged, have the power tool repaired before use. Many accidents are caused by poorly maintained power tools.

**f) Keep cutting tools sharp and clean.** Properly maintained cutting tools with sharp cutting edges are less likely to bind and are easier to control.

**g) Use the power tool, accessories and tool bits etc. in accordance with these instructions, taking into account the working conditions and the work to be performed.** Use of the power tool for operations different from those intended could result in a hazardous situation.

**h) Keep handles and grasping surfaces dry, clean and free from oil and grease.** Slippery handles and grasping surfaces do not allow for safe handling and control of the tool in unexpected situations.

**(2.6) 5) General Power Tool Safety Warnings [Service]**

**a) Have your power tool serviced by a**

**qualified repair person using only identical replacement parts.** This will ensure that the safety of the power tool is maintained.

**(2.7) HEALTH ADVICE**

**WARNING:** When using this machine, dust particles may be produced. In some instances, depending on the materials you are working with, this dust can be particularly harmful. If you suspect that paint on the surface of material you wish to cut contains lead, seek professional advice. Lead based paints should only be removed by a professional and you should not attempt to remove it yourself.

Once the dust has been deposited on surfaces, hand to mouth contact can result in the ingestion of lead. Exposure to even low levels of lead can cause irreversible brain and nervous system damage. The young and unborn children are particularly vulnerable. You are advised to consider the risks associated with the materials you are working with and to reduce the risk of exposure.

As some materials can produce dust that may be hazardous to your health, we recommend the use of an approved face mask with replaceable filters when using this machine.

**You should always:**

- Work in a well-ventilated area.
- Work with approved safety equipment, such as dust masks that are specially designed to filter microscopic particles.

**(2.8) WARNING:** the operation of any power tool can result in foreign objects being thrown towards your eyes, which could result in severe eye damage. Before beginning power tool operation, always wear safety goggles or safety glasses with side shield or a full face shield where necessary.

**SAFETY INSTRUCTIONS FOR ALL SAWS [Cutting procedures]**

**a) DANGER: Keep hands away from cutting area and the blade. Keep your second hand on auxiliary handle, or motor housing.** If both hands are holding the saw, they cannot be cut by the blade.

**b) Do not reach underneath the workpiece.**

The guard cannot protect you from the blade below the workpiece.

**c) Adjust the cutting depth to the thickness of the workpiece.** Less than a full tooth of the blade teeth should be visible below the workpiece.

**d) Never hold the workpiece in your hands or across your leg while cutting. Secure the workpiece to a stable platform.** It is important to support the work properly to minimise body exposure, blade binding, or loss of control.

**e) Hold the power tool by insulated gripping surfaces, when performing an operation where the cutting tool may contact hidden wiring or its own cord.** Contact with a "live" wire will also make exposed metal parts of the power tool 'live' and could give the operator an electric shock.

**f) When ripping, always use a rip fence or straight edge guide.** This improves the accuracy of cut and reduces the chance of blade binding.

**g) Always use blades with correct size and shape (diamond versus round) of arbour holes.** Blades that do not match the mounting hardware of the saw will run off-centre, causing loss of control.

**h) Never use damaged or incorrect blade washers or bolt.** The blade washers and bolt were specially designed for your saw, for optimum performance and safety of operation.

**(3.2) [Kickback causes and related warnings]**

Kickback is a sudden reaction to a pinched, jammed or misaligned saw blade, causing an uncontrolled saw to lift up and out of the workpiece toward the operator;

When the blade is pinched or jammed tightly by the kerf closing down, the blade stalls and the motor reaction drives the unit rapidly back toward the operator;

If the blade becomes twisted or misaligned in the cut, the teeth at the back edge of the blade can dig into the top surface of the wood causing the blade to climb out of the kerf and jump back toward the operator.

(3.3) Kickback is the result of saw misuse and/or incorrect operating procedures or conditions and can be avoided by taking proper precautions as given below.

**a) Maintain a firm grip with both hands on the saw and position your arms to resist kickback forces. Position your body to either side of the blade, but not in line with the blade.** Kickback could cause the saw to jump backwards, but kickback forces can be controlled by the operator, if proper precautions are taken.

**b) When blade is binding, or when interrupting a cut for any reason, release the trigger and hold the saw motionless in the material until the blade comes to a complete stop. Never attempt to remove the saw from the work or pull the saw backward while the blade is in motion or kickback may occur.** Investigate and take corrective actions to eliminate the cause of blade binding.

**c) When restarting a saw in the workpiece, centre the saw blade in the kerf so that the saw teeth are not engaged into the material.** If a saw blade binds, it may walk up or kickback from the workpiece as the saw is restarted.

**d) Do not use dull or damaged blades.** Unsharpened or improperly set blades produce narrow kerf causing excessive friction, blade binding and kickback.

**e) Blade depth and bevel adjusting locking levers must be tight and secure before making a cut.** If the blade adjustment shifts while cutting it may cause binding and kickback.

**f) Blade depth and bevel adjusting locking levers must be tight and secure before making the cut.** If blade adjustment shifts while cutting, it may cause binding and kickback.

**g) Use extra caution when sawing into existing walls or other blind areas.** The protruding blade may cut objects that can cause kickback.

**LOWER GUARD FUNCTION**

**a) Check the lower guard for proper closing before each use. Do not operate the saw if the lower guard does not move freely and close instantly. Never clamp or tie the lower guard into the open position.** If the saw is

accidentally dropped, the lower guard may be bent. Raise the lower guard with the retracting handle and make sure it moves freely and does not touch the blade or any other part, in all angles and depths of cut.

**b) Check the operation of the lower guard spring. If the guard and the spring are not operating properly, they must be serviced before use.** Lower guard may operate sluggishly due to damaged parts, gummy deposits, or a build-up of debris.

**c) The lower guard may be retracted manually only for special cuts such as "plunge cuts" and "compound cuts". Raise the lower guard by the retracting handle and as soon as the blade enters the material, the lower guard must be released.**

For all other sawing, the lower guard should operate automatically.

**d) Always observe that the lower guard is covering the blade before placing the saw down on bench or floor.** An unprotected, coasting blade will cause the saw to walk backwards, cutting whatever is in its path. Be aware of the time it takes for the blade to stop after switch is released.

### **ADDITIONAL SAFETY INSTRUCTIONS FOR CIRCULAR SAWS**

**a) Do not use High Speed Steel (HSS) saw blades.**

**b) Inspect the machine and the blade before each use.** Do not use deformed, cracked, worn or otherwise damaged blades.

**c) Never use the saw without the original guard protection system.** Do not lock the moving guard in the open position. Ensure that the guard operates freely without jamming.

**d) Only use blades that comply with the characteristics specified in this manual.** Before using accessories, always compare the maximum allowed RPM of the accessory with the RPM of the machine.

**e) Do not use any abrasive wheels.**

**f) Use only blade diameter(s) in accordance with the markings.**

(3.4) **WARNING:** If any parts are missing, do

not operate your machine until the missing parts are replaced. Failure to follow this rule could result in serious personal injury.

#### **(4.1) GETTING STARTED - UNPACKING**

**Caution:** This packaging contains sharp objects. Take care when unpacking. Remove the machine, together with the accessories supplied from the packaging. Check carefully to ensure that the machine is in good condition and account for all the accessories listed in this manual. Also make sure that all the accessories are complete. If any parts are found to be missing, the machine and its accessories should be returned together in their original packaging to the retailer.

Do not throw the packaging away; keep it safe throughout the warranty period. Dispose of the packaging in an environmentally responsible manner. Recycle if possible.

Do not let children play with empty plastic bags due to the risk of suffocation.

#### **(4.3) Evolution Instruction Manuals**

Evolution Power Tools provides each product with an Instruction Manual.

Each dedicated manual is carefully constructed and designed to provide easily accessible and useful information regarding the safe use, care and maintenance of the product. Referencing the information contained within the manual will allow the operator to fully and safely exploit the potential of the machine. Evolutions policy of continual product development may mean that, very occasionally, the contents of a manual may not completely reflect the latest improvements or upgrades that have been incorporated into a particular product. Upgrades/improvements to the specification of a product could come about as a consequence of technological advances or changes to the legislative framework of the receiving country, etc. If you are at all unsure about any aspect of the use, care or maintenance of an Evolution product, contact the relevant Evolution helpline where up to date information and extra advice will be available.

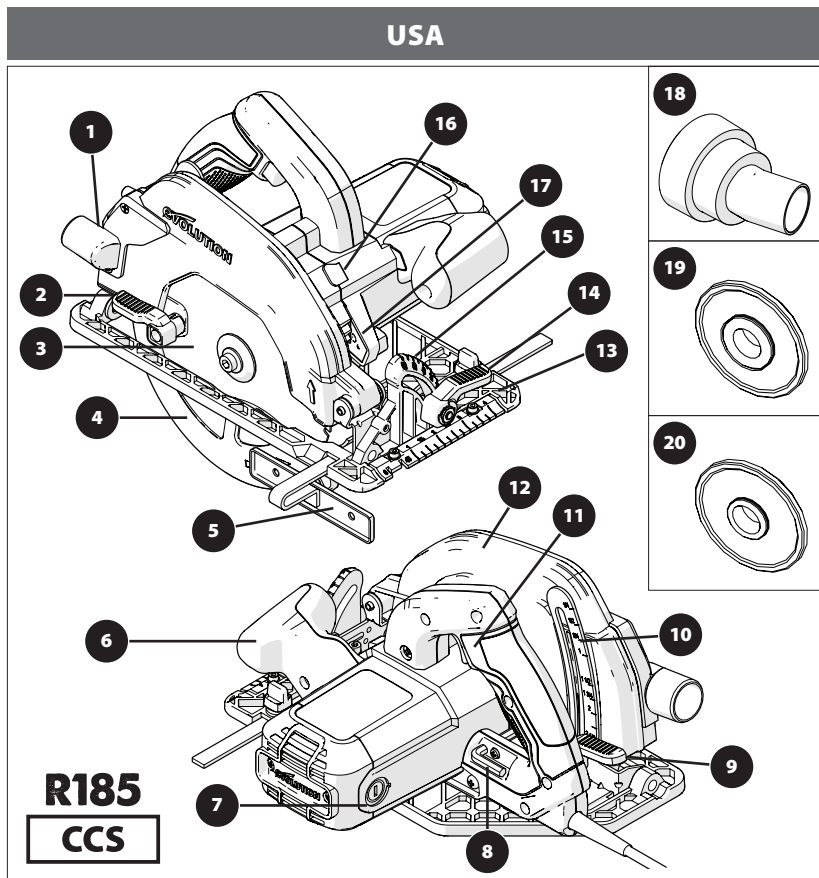

- |   |  |
|---|--|
| <ul style="list-style-type: none"> <li>1. CUT MATERIAL EJECTION PORT</li> <li>2. THUMB LEVER</li> <li>3. MULTI-MATERIAL TCT BLADE</li> <li>4. LOWER BLADE GUARD</li> <li>5. PARALLEL EDGE GUIDE</li> <li>6. ERGONOMIC FRONT HANDLE</li> <li>7. CARBON BRUSHES</li> <li>8. 5/16" HEX KEY (BLADE CHANGE)</li> <li>9. DEPTH ADJUSTMENT LOCKING LEVER</li> <li>10. DEPTH SCALE</li> <li>11. REAR HANDLE ON/OFF SWITCH</li> <li>12. UPPER BLADE GUARD</li> </ul> | <ul style="list-style-type: none"> <li>13. PRECISION ENGINEERED SOLE PLATE</li> <li>14. BEVEL ADJUSTMENT THUMB LEVER</li> <li>15. PROTRACTOR SCALE</li> <li>16. ARBOR LOCK BUTTON</li> <li>17. LED LIGHT</li> <li>18. DUST PORT CONNECTOR</li> <li>19. 25/32" INNER BLADE FLANGE</li> <li>20. 5/8" INNER BLADE FLANGE</li> </ul> |
|---|--|

USA

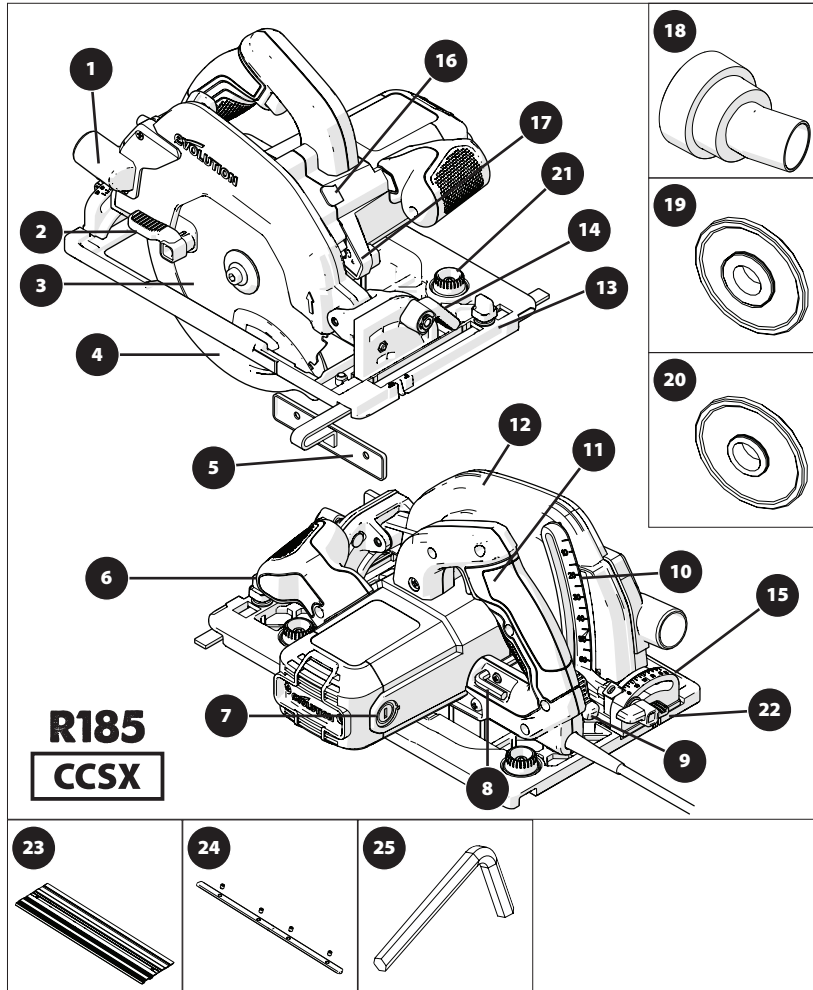

**R185**  
**CCSX**

- 1. CUT MATERIAL EJECTION PORT
- 2. THUMB LEVER
- 3. MULTI-MATERIAL TCT BLADE
- 4. LOWER BLADE GUARD
- 5. PARALLEL EDGE GUIDE
- 6. ERGONOMIC FRONT HANDLE
- 7. CARBON BRUSHES
- 8. 5/16" HEX KEY (BLADE CHANGE)
- 9. DEPTH ADJUSTMENT LEVER

- 10. DEPTH SCALE
- 11. REAR HANDLE ON/OFF SWITCH
- 12. UPPER BLADE GUARD
- 13. PRECISION ENGINEERED TRACK COMPATIBLE SOLE PLATE
- 14. THUMB LEVER
- 15. REAR PROTRACTOR SCALE
- 16. ARBOR LOCK BUTTON
- 17. LED LIGHT

- 18. DUST PORT CONNECTOR
- 19. 25/32" INNER BLADE FLANGE
- 20. 5/8" INNER BLADE FLANGE
- 21. TRACK ADJUST TURN BUTTONS
- 22. REAR BEVEL THUMB SCREW
- 23. 3x 13-3/8" TRACK
- 24. 4x TRACK CONNECTOR BARS
- 25. 1/8" HEX KEY (TRACK)

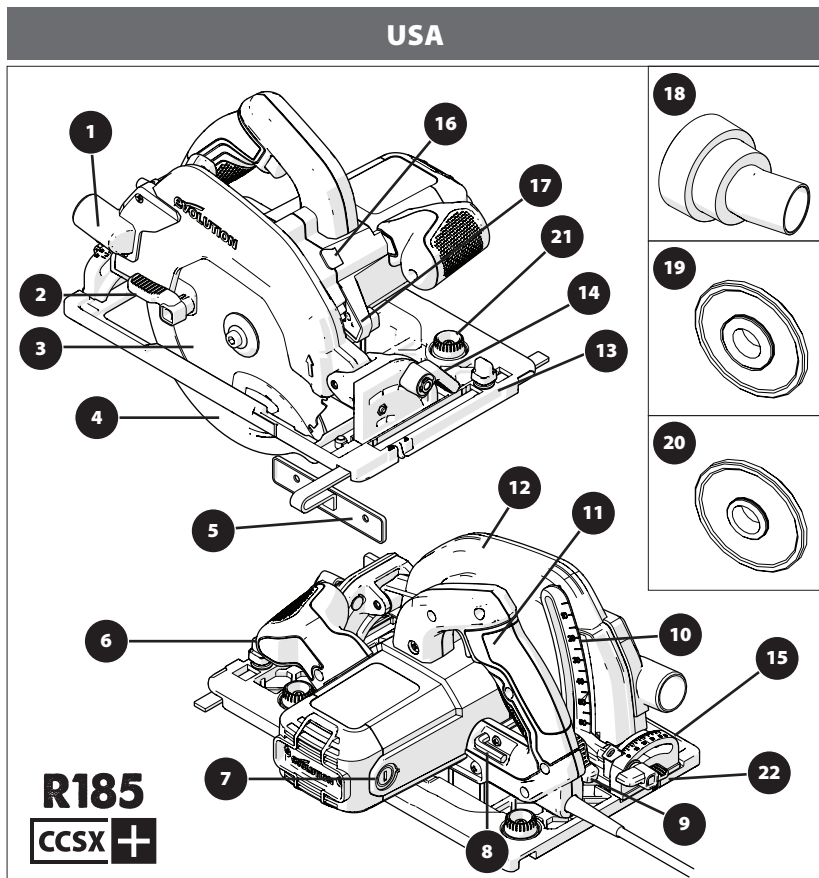

- 1. CUT MATERIAL EJECTION PORT
- 2. THUMB LEVER
- 3. MULTI-MATERIAL TCT BLADE
- 4. LOWER BLADE GUARD
- 5. PARALLEL EDGE GUIDE
- 6. ERGONOMIC FRONT HANDLE
- 7. CARBON BRUSHES
- 8. 8MM HEX KEY (BLADE CHANGE)
- 9. DEPTH ADJUSTMENT LOCKING LEVER
- 10. DEPTH SCALE
- 11. REAR HANDLE ON/OFF SWITCH
- 12. UPPER BLADE GUARD

- 13. PRECISION ENGINEERED TRACK COMPATIBLE SOLE PLATE
- 14. THUMB LEVER
- 15. REAR PROTRACTOR SCALE
- 16. ARBOR LOCK BUTTON
- 17. LED LIGHT
- 18. DUST PORT CONNECTOR
- 19. 25/32" INNER BLADE FLANGE
- 20. 5/8" INNER BLADE FLANGE
- 21. TRACK ADJUST TURN BUTTONS
- 22. REAR BEVEL THUMB SCREW

**UK / EU / AUS**

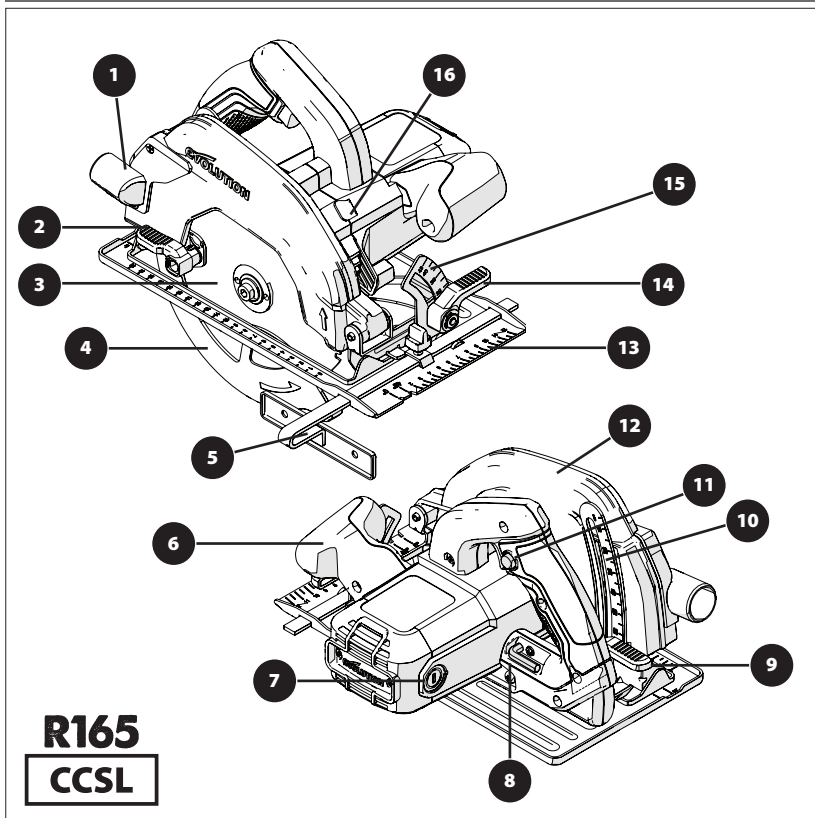

- |  |                                     |
|--|-------------------------------------|
| 1. CUT MATERIAL EJECTION PORT                            | 12. UPPER BLADE GUARD               |
| 2. THUMB LEVER   | 13. PRECISION ENGINEERED SOLE PLATE |
| 3. MULTI-MATERIAL TCT BLADE                              | 14. THUMB LEVER                     |
| 4. LOWER BLADE GUARD                                     | 15. PROTRACTOR SCALE                |
| 5. PARALLEL EDGE GUIDE                                   | 16. ARBOR LOCK BUTTON               |
| 6. ERGONOMIC FRONT HANDLE                                |                                     |
| 7. CARBON BRUSHES  |                                     |
| 8. 8MM HEX KEY (BLADE CHANGE)                            |                                     |
| 9. DEPTH ADJUSTMENT LOCKING LEVER                        |                                     |
| 10. DEPTH SCALE  |                                     |
| 11. REAR HANDLE INCORPORATING SAFETY START ON/OFF SWITCH |                                     |

DE

FR

ES

PL

PT

RO

**UK / EU**

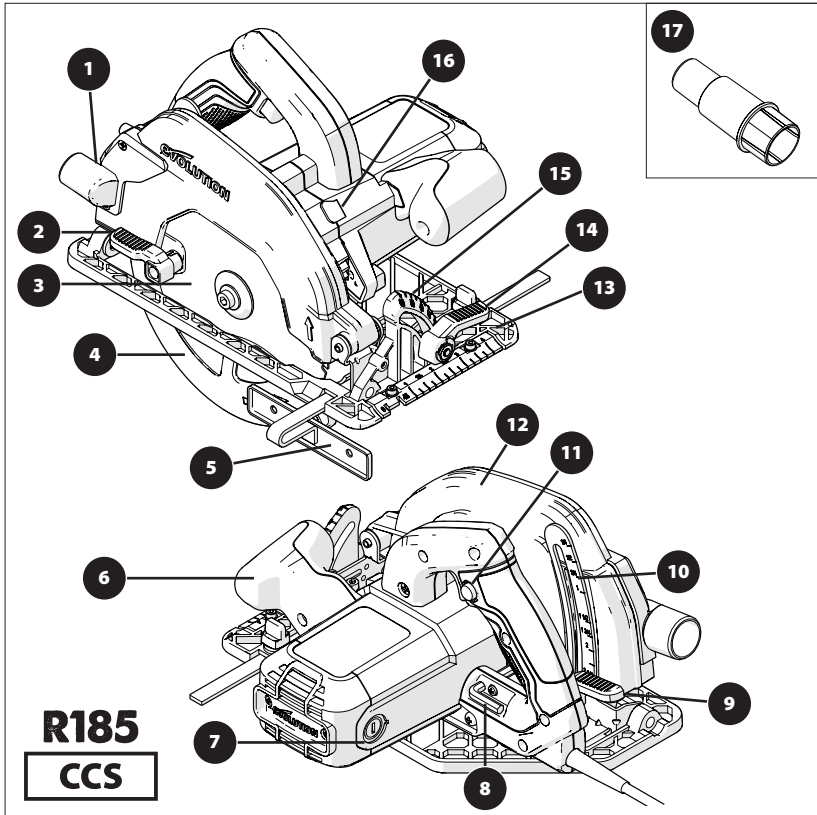

**R185  
CCS**

- |   |   |
|---|---|
| <ul style="list-style-type: none"> <li>1. CUT MATERIAL EJECTION PORT</li> <li>2. THUMB LEVER</li> <li>3. MULTI-MATERIAL TCT BLADE</li> <li>4. LOWER BLADE GUARD</li> <li>5. PARALLEL EDGE GUIDE</li> <li>6. ERGONOMIC FRONT HANDLE</li> <li>7. CARBON BRUSHES</li> <li>8. 8MM HEX KEY (BLADE CHANGE)</li> <li>9. DEPTH ADJUSTMENT LOCKING LEVER</li> <li>10. DEPTH SCALE</li> <li>11. REAR HANDLE INCORPORATING SAFETY START ON/OFF SWITCH</li> </ul> | <ul style="list-style-type: none"> <li>12. UPPER BLADE GUARD</li> <li>13. PRECISION ENGINEERED SOLE PLATE</li> <li>14. THUMB LEVER</li> <li>15. PROTRACTOR SCALE</li> <li>16. ARBOR LOCK BUTTON</li> <li>17. DUST PORT CONNECTOR</li> </ul> |
|---|---|



**UK / EU**

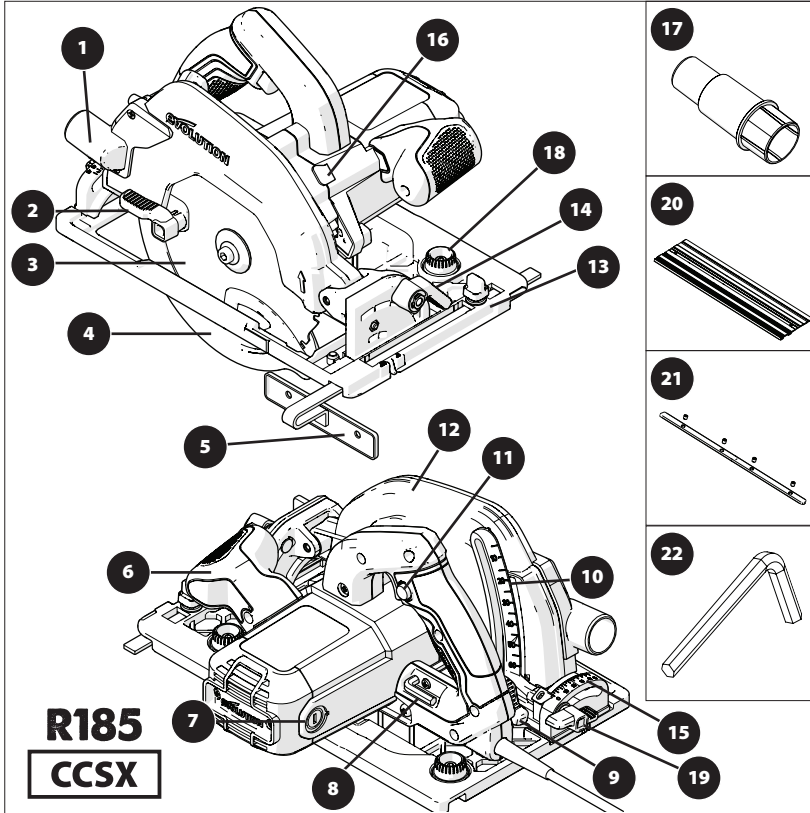

- |   |  |
|---|--|
| <ul style="list-style-type: none"> <li>1. CUT MATERIAL EJECTION PORT</li> <li>2. THUMB LEVER</li> <li>3. MULTI-MATERIAL TCT BLADE</li> <li>4. LOWER BLADE GUARD</li> <li>5. PARALLEL EDGE GUIDE</li> <li>6. ERGONOMIC FRONT HANDLE</li> <li>7. CARBON BRUSHES</li> <li>8. 8MM HEX KEY (BLADE CHANGE)</li> <li>9. DEPTH ADJUSTMENT LOCKING LEVER</li> <li>10. DEPTH SCALE</li> <li>11. REAR HANDLE INCORPORATING SAFETY START ON/OFF SWITCH</li> </ul> | <ul style="list-style-type: none"> <li>12. UPPER BLADE GUARD</li> <li>13. PRECISION ENGINEERED TRACK COMPATIBLE SOLE PLATE</li> <li>14. THUMB LEVER</li> <li>15. REAR PROTRACTOR SCALE</li> <li>16. ARBOR LOCK BUTTON</li> <li>17. DUST PORT CONNECTOR</li> <li>18. TRACK ADJUST TURN BUTTONS</li> <li>19. REAR BEVEL THUMB SCREW</li> <li>20. 3x 340mm TRACK</li> <li>21. 4x TRACK CONNECTOR BARS</li> <li>22. 3mm HEX KEY</li> </ul> |
|---|--|

DE

FR

ES

PL

PT

RO

**UK / EU**

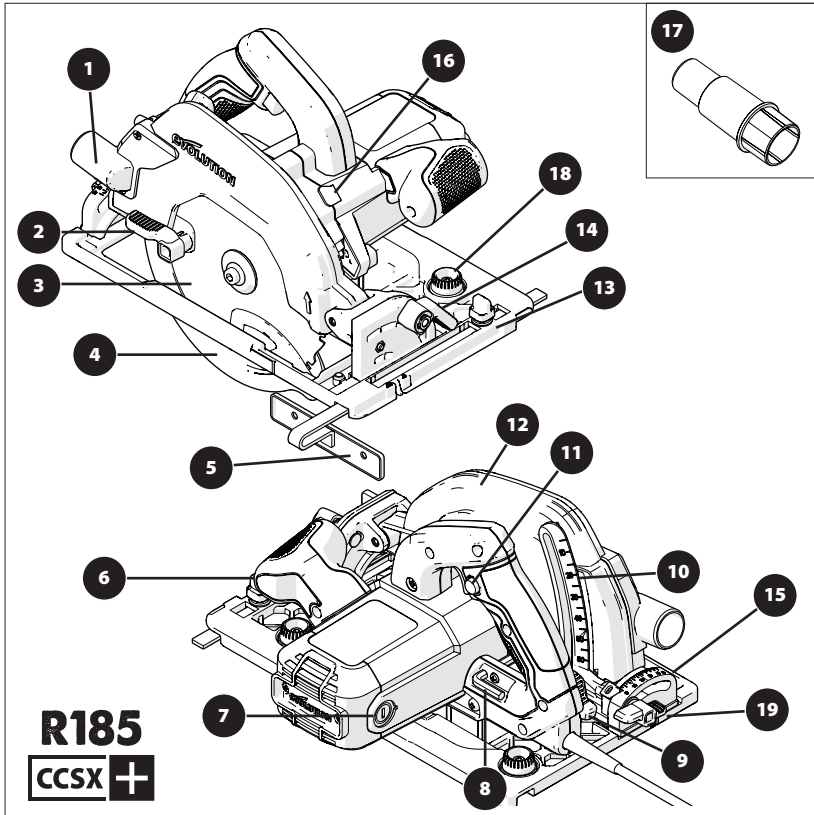

- 1. CUT MATERIAL EJECTION PORT
- 2. THUMB LEVER
- 3. MULTI-MATERIAL TCT BLADE
- 4. LOWER BLADE GUARD
- 5. PARALLEL EDGE GUIDE
- 6. ERGONOMIC FRONT HANDLE
- 7. CARBON BRUSHES
- 8. 8MM HEX KEY (BLADE CHANGE)
- 9. DEPTH ADJUSTMENT LOCKING LEVER
- 10. DEPTH SCALE
- 11. REAR HANDLE INCORPORATING SAFETY START ON/OFF SWITCH

- 12. UPPER BLADE GUARD
- 13. PRECISION ENGINEERED TRACK COMPATIBLE SOLE PLATE
- 14. THUMB LEVER
- 15. REAR PROTRACTOR SCALE
- 16. ARBOR LOCK BUTTON
- 17. DUST PORT CONNECTOR
- 18. TRACK ADJUST TURN BUTTONS
- 19. REAR BEVEL THUMB SCREW

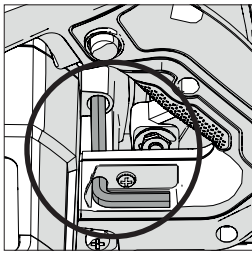

**Fig. 1**

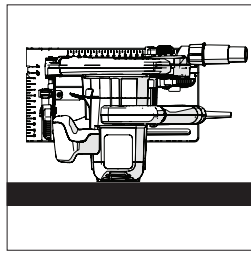

**Fig. 2**

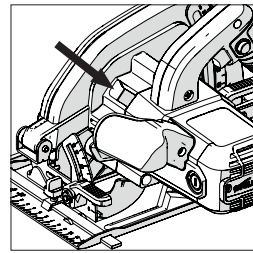

**Fig. 3**

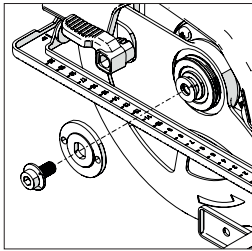

**Fig. 4**

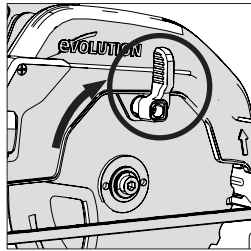

**Fig. 5**

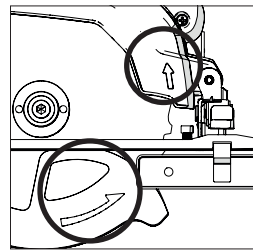

**Fig. 6**

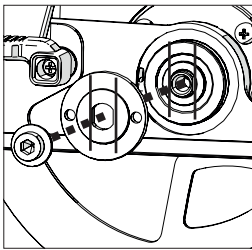

**Fig. 7a**

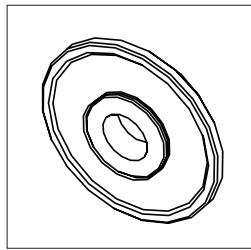

**Fig. 7b**

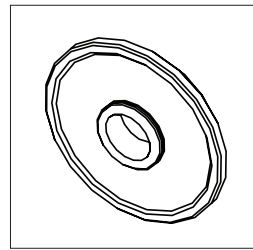

**Fig. 7c**

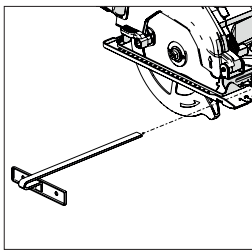

**Fig. 8**

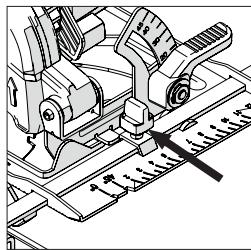

**Fig. 9**

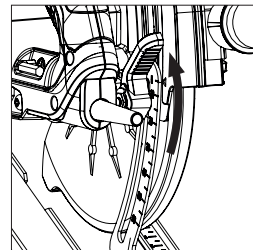

**Fig. 10**

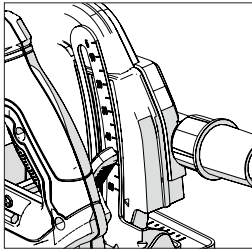

**Fig. 11**

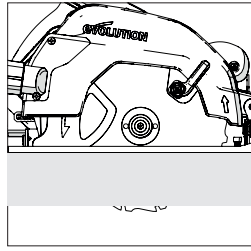

**Fig. 12**

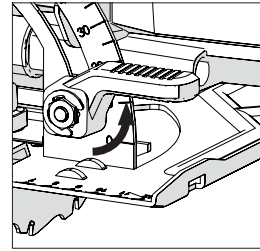

**Fig. 13**

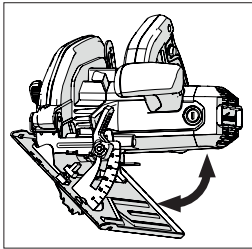

**Fig. 14**

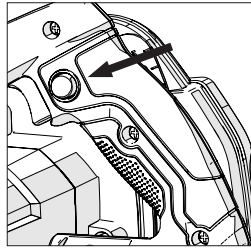

**Fig. 15**

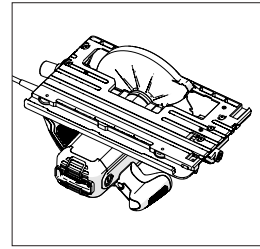

**Fig. 16**

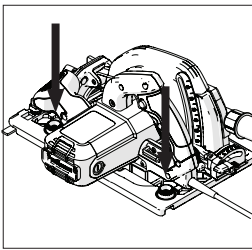

**Fig. 17**

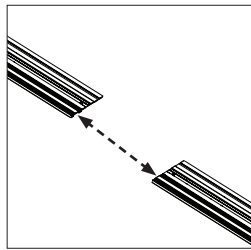

**Fig. 18**

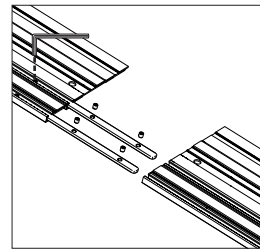

**Fig. 19**

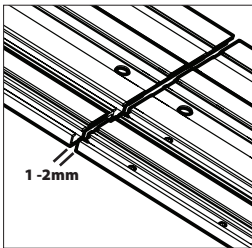

**Fig. 20**

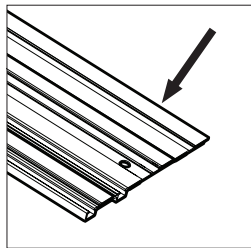

**Fig. 21**

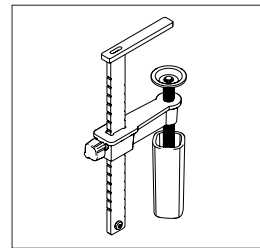

**Fig. 22**

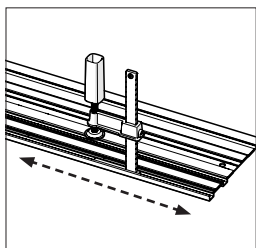

Fig. 23

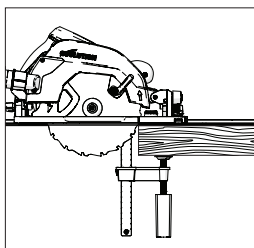

Fig. 24

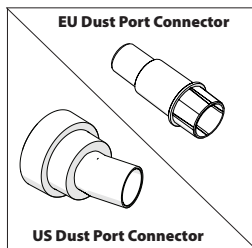

Fig. 25

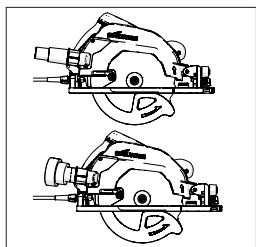

Fig. 26

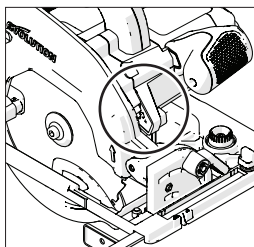

Fig. 27

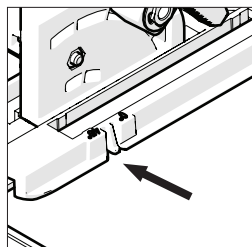

Fig. 28

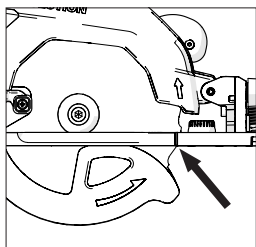

Fig. 29

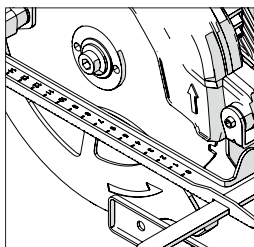

Fig. 30

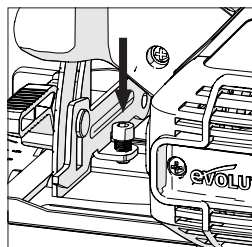

Fig. 31

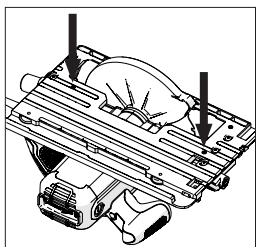

Fig. 32

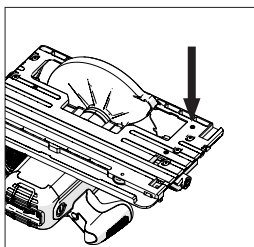

Fig. 33

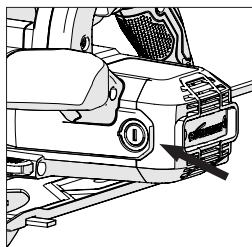

Fig. 34

## (10) PREPARATION

**WARNING:** Always disconnect the machine from the power source before making any adjustments.

**Note:** These machines are equipped with an approved power cord and plug for the intended country of use. Do not alter or modify the power cord.

### (10.1) INSTALLING / REMOVING A BLADE

**WARNING:** Use only genuine Evolution blades (or those approved by Evolution Power Tools), which are designed for use in these machines. Ensure that the maximum speed of the blade is compatible with the machine. Only perform this operation with the machine disconnected from the power supply.

**Note:** It is recommended that the operator considers wearing protective gloves when handling the blade during installation or when changing the machines blade.

- Locate the supplied Blade Change Hex Key which is housed in the onboard storage facility (similarly position on all machines). **(Fig. 1)**
- Place saw on a level, secure surface.

**Note:** All machines can, with care, be balanced on the flat end of the motor housing casing, **(Fig. 2)** making access to the blade and blade fixings very convenient.

- Locate the machines arbor lock button (which is similarly positioned on all machines). Lock the machines arbor by operating the arbor lock button. **(Fig. 3)**.

**Note:** Slowly rotating the blade by hand, whilst gently pressing the arbor lock button will aid arbor lock engagement.

- Using the Hex Key, loosen and remove the arbor socket headed screw, associated fixings, and outer blade drive flange. **(Fig. 4)**

**Note:** The socket headed arbor screw is equipped with a standard screw thread.

Turn the screw clockwise to tighten. Turn the screw counter clockwise to loosen.

- Safely store the outer blade flange and associated fixings.
- Rotate the lower blade guard up into the upper blade guard using the manual thumb lever. **(Fig. 5)**
- Carefully remove the blade (if fitted) from the machine.
- Thoroughly clean inner and outer blade drive flanges.

**Note:** The inner blade flange can be left in place if desired, but it should be checked and thoroughly cleaned. If it is removed from the machine it must be replaced back in the same orientation as it was before removal.

- Thoroughly clean the blade around the bore area (both surfaces) where the blade flanges will touch and clamp the blade.
- Install the (new) blade.
- Ensure that the direction of rotation arrows printed on the blade, match the direction of rotation arrows found on the machines upper and lower blade guards. **(Fig. 6)**
- Reinstall the outer drive flange, the socket headed arbor screw, and its associated fixings.

**Note:** The outer drive flange has a specially machined bore which incorporates two opposed 'flats' **(Fig. 7a)** These 'flats' engage with two complimentary 'flats' machined into the machines arbor shaft.

- Re-engage the arbor lock and tighten the arbor socket headed screw securely using the Hex Key.
- Release the arbor lock button
- Return the Hex Key to its dedicated storage position.
- Check that the arbor lock has fully released by manually rotating the blade.
- Check the operation of the lower blade guard.

**Note:** For North American market only, a dual side arbor flange is included, to allow 1" bore blades **(Fig. 7b)** and 5/8" bore blades **(Fig. 7c)**.

### (11) PARALLEL EDGE GUIDE

A Parallel Edge Guide (**Fig. 8**) which can be particularly helpful when rip cutting, is supplied with all CCS machines. The guide can be fitted to the front of the sole plate.

The guides arm should be inserted through the rectangular slots positioned at either side (front) of the pressed steel sole plate, and slid under the centrally located adjustment locking screw. (**Fig. 9**)

**Note:** The Parallel Edge Guide can be fitted on either side of the sole plate.

**WARNING:** Only fit and adjust the Guide with the machine disconnected from the power supply.

**Note:** The arm of the Parallel Edge Guide must pass through all of the rectangular slots provided in the sole plate.

**WARNING:** It is potentially dangerous to install, and try to use the Edge Guide with the arm passing through only one (1) of the machined rectangular sole plate slots. Adjust the edge guide so that it is at the required distance from the blade and tighten the adjusting screw. Check that the edge guide is parallel to the saw blade.

### (12) CUTTING DEPTH ADJUSTMENT

**Note:** All CCS machines share the same general depth adjustment fixtures/fittings and employ the same basic technique for setting the blade depth.

- Loosen the Depth Adjustment Locking Mechanism by pulling the operating lever upwards. (**Fig. 10**)
- Adjust/re-position the sole plate to give the required cutting depth (the amount by which the blade protrudes through the sole plate).

**Note:** A depth scale can be found on the depth adjustment quadrant, with a corresponding index mark incorporated into the adjacent area of the machines upper blade guard. (**Fig. 11**) Using these features can aid rapid setting.

**Note:** Although the depth scale and index mark are very useful, enabling rapid depth setting, using them should always be regarded as a guide to the setting achieved.

If a very precise depth of cut is required, then the blade setting should be checked with an engineers precision ruler (not supplied) or similar and adjusted accordingly.

- In most cases the cutting depth should be set at the thickness of the material to be cut plus the depth of half of a saw tooth (tip of the tooth to the tooth root). (**Fig.12**)
- Tighten the Depth Adjustment Locking Mechanism by pushing the operating lever downwards to securely to lock in the machine in the required position.

### (13) CUTTING ANGLE (BEVEL) ADJUSTMENT

All CCSL & CCSX machines have the facility to tilt the blade through (up to) 45° and all CCS machines have the facility to tilt the blade through (up to) 60° to the left hand side. Bevel cuts are therefore possible.

**Note:** The blade is at the vertical position when the protractor scale reads 0°.

**Note:** A protractor scale (0°- 45° or 0°- 60°) is incorporated on the Bevel Locking quadrant found at the front of the soleplate. Using this will aid rapid bevel angle setting but should be regarded as a guide only.

If a very precise bevel angle is required, then the blade setting should be checked using a vernier angle gauge (not supplied) and adjusted accordingly.

- Loosen the Bevel Locking Mechanism found at the front of the machine, by pulling the lever upwards. (**Fig. 13**)
- Tilt the blade to the required angle as indicated on the quadrant protractor scale. (**Fig. 14**)
- Tighten the Bevel Locking Mechanism securely when the desired bevel angle has been achieved by pushing the lever downwards.

### (14) OPERATING ADVICE (PRE OPERATION CHECKS)

**Note:** As all operating environments will be unique and diverse, Evolution Power Tools offers

the following general advice on safe operational procedures and practices for the consideration of the operator.

This advice cannot be exhaustive as Evolution has no influence on the type of workshops or working environments in which these machines may be used.

We recommend that the operator seeks advice from a competent authority or the workshop supervisor if they are at unsure of any aspect of using these machines.

It is important that routine safety checks are carried out (at each time of usage) before the operator uses the machine.

**WARNING:** These pre-use safety checks should be carried out with the machine disconnected from the mains power supply.

- Check that all safety guards are operating correctly, and that all adjustment handles/screws are securely tightened.
- Check that the blade is secure and installed correctly. Also check that it is the correct blade for the material being cut.
- Check the integrity of the power cord.
- Whenever possible clamp the workpiece to a rigid support structure such as a workbench, saw horse or similar.
- The operator should always be aware of the position and routing of the power cable.

#### (15) PPE

- The operator should wear all relevant PPE (Personal Protection Equipment) necessary for the task ahead.  
This could include safety glasses, full face mask, dust masks, safety shoes etc.

**Note:** All CCS series machines are equipped with a cutting line debris blower. This directs air from a motor driven fan towards the area to the front of the blade, thus keeping the cutting line relatively debris free. This feature will aid the operator sight and follow the progress of the saw blade along the cut, keeping any marking-out lines visible.

**WARNING:** Any and all dust created is potentially prejudicial to health.

Some materials can be particularly harmful, and the operator should always wear a dust mask which is suitable for the material being worked with. Professional help and advice should be sought if the operator is at all unsure about the potential toxicity of the material to be cut.

**WARNING:** These machines must never be used to cut Asbestos or any material that contains, or is suspected to contain, Asbestos.

Consult/inform the relevant authorities, and seek additional guidance if Asbestos contamination is suspected.

#### (16) ON/OFF TRIGGER SWITCH

**Note:** All machines destined for the European and Australian market are equipped with a 'safety start' trigger switch to enhance operator safety. **(Fig.15)**

To start the motor:

- Push in the safety lock button on the side of the handle with your thumb.
- Depress the trigger switch.

To stop the motor:

- Release the trigger switch.

**WARNING:** The motor should never be started with the saw blade in direct contact with any surface of the workpiece.

**Note:** Machines destined for the North American market are fitted with an ON/OFF Trigger switch which does not incorporate a 'safety start' trigger switch.

**WARNING:** If the saw is 'live' (LED Light 'ON'), avoid unintentionally starting the motor when picking up the machine from a workbench or similar. Accidentally depressing the ON/OFF Trigger switch (positioned in the main handle) when picking up the machine from rest will cause the motor to start.



## CUTTING TRACKS

**Evolution CCSX series machines (refer to the Specification Page for applicable models) have been engineered and featured in such a way as to make them Cutting Track compatible.**

**Note:** Any circular saw that is capable of being used with a Cutting Track will have a channel along the under surface of the sole plate (**Fig. 16**) Evolution machines so equipped can be attached to, and used with most Cutting Tracks (Guides) currently available.

**Note:** Consult the documentation supplied with the track by the track manufacturer. The supplied documentation will normally give the assembly instructions for the track, as well as information regarding the safe working practices that need to be employed when using such equipment.

### Cutting Tracks can be employed where:

- The use of a chop or circular saw could present Health and Safety (H&S) or other practical workplace issues. For example when working on a construction site where very close and accurate control may be necessary, (working on a roof or on a scaffolding platform, etc.) using a cutting track may provide the user with some extra (and safe) operational possibilities.
- Accurate cuts across or along large workpieces are required. For example on frames, doors, large boards or wall panels, etc, a cutting track/guide could eliminate the need to use a circular saw in 'free hand' mode.

**Note:** Evolution's cutting track compatible machines have two (2) cams which project into the sole plate channel (one at each end). 'Turn-buttons' (**Fig. 17**) allow the operator to rotate these cams.

Adjusting these cams will reduce slightly the effective width of the sole plate channel. This could be necessary to accommodate any

slight variation of rail width that can occur during the manufacture of the track extrusion. Track rail widths produced by different track manufacturers may also vary slightly.

**Note:** The operator should adjust these cams so that when the machine is placed correctly on a track it can be moved forwards or backwards easily and smoothly but without any lateral movement (wobble) being detectable.

## EVOLUTION CUTTING TRACKS

Some Evolution machines (depending upon the model and market destination) are supplied with a Cutting Track.

**Note:** Evolution Cutting Tracks are available as a customer purchase option. Contact your supplier or Evolution Power Tools for further details.

## THE TRACK

The Evolution Track system consists of two (2) or three (3) precision extruded alloy sections.

(**Fig. 18**) These sections must be joined together using the joining bars supplied. (**Fig. 19**)

### To Join The Sections Together (**Fig. 19**):

- Slide the bars into the 'T' slots found on the under surface of the extrusions.
- Ensure that an equal length (approximately) of the bars is inserted into both of the sections to be joined together.
- Tighten the socket headed grub-screws to secure the sections together.

**Note:** It is important to leave a small gap between joined sections of between 1 to 2mm. This will ensure that when a circular saw is placed upon and used with an Evolution Cross Cutting Track it will slide smoothly along the entire track length.

## SAW TO TRACK COMMISSIONING

**Note:** The following guidelines refer to Evolution circular saws and the Evolution Cutting Track. Consult the information supplied by the saw and/or the cutting track

manufacturers if a non-Evolution circular saw or cutting track is to be used.

Before the first use of the Evolution Cutting Track the Splinter Guard Strip (Fig. 21) needs to match the saw and blade.

**To match saw to track:**

- Fully assemble the Cutting Track.
- Refer to the section entitled 'Track Positioning and Clamping'. Clamp the track to an appropriate piece of spare or scrap material.
- Set the saw blade to a depth suitable for the scrap workpiece selected.
- Ensure that no obstructions are present beneath the path of the blade.
- Refer to the section 'Track Positioning and Clamping'. Place the circular saw correctly on the track.
- Start the motor and allow it to reach full speed.
- Smoothly and slowly push the circular saw along the full length of the track until the blade has cut through the entire length of the Splinter Guard Strip.

**Note:** This process will match a specific saw to a specific track.

If a different saw is used on such a prepared track, the Splinter Guard Strip may not provide the same level of protection as the dedicated saw to track configuration.

**Note:** The Splinter Guard Strip should be regarded as a consumable item. Over time it will wear and abrade and will therefore need replacing. It may also need replacing if a different circular saw or saw blade (one with a different kerf width) from the original dedicated configuration is to be used.

**REPLACEABLE SPLINTER GUARD STRIP**

As a consumable item Replaceable Splinter Guard Strip should be checked at regular

intervals for damage or abrasion caused by 'wear and tear'. Replace the strip if any damage or significant wear is apparent.

Replacement strips are available. Consult your supplier or contact Evolution using the appropriate helpline. The Replaceable Splinter Guard Strip supplied is a direct substitution to the fitted original. Simply pull the old strip gently from the track and replace with the new strip.

**Note:** If a new strip is fitted, the Saw to Track matching process must be repeated.

**EVOLUTION TRACK CLAMPS**

The Evolution Speed Clamp (Fig. 22) is purpose designed to work with the Evolution Cutting Track.

**Note:** Extra clamps can be purchased from Evolution Power Tools or your local supplier.

Evolution clamps fit into and can slide along the 'T' slots found on the under surface of the alloy extrusions. (Fig. 23)

This enables the operator to locate the clamps (one is required at each end of the track) in positions which afford the maximum security, and rigidity of the Cutting Track to the workpiece.

**TRACK POSITIONING & CLAMPING**

**Note:** The following guidelines are given as advice. Evolution has no influence over the working environments or conditions in which this equipment is used.

**WARNING:** If this equipment is to be used on a construction site, the operator should consult the relevant person who has responsibility for Health and Safety for further 'on site' specific safety requirements or instructions.

- Mark out clearly the workpiece and particularly the 'line of cut' along which the saw blade is required to travel.
- Assemble the Cutting Track with as many

sections as required to span the workpiece including an allowance for the overhang needed.

- Using Evolution Speed Clamps (the preferred option) or suitable 'G' clamps position the Track on the workpiece and secure by tightening the clamps.
- **Ensure that the edge of the Splinter Guard Strip runs exactly along the marked out cutting line.**

**WARNING:** The Cutting Track must overhang the workpiece at the 'lead in' edge. (**Fig. 24**) The lower blade guard will need to be retracted manually and pivot upwards into the upper blade guard as the circular saw is placed on the track.

**WARNING:** In this position the blade is exposed. **DO NOT** press the trigger until the following safety checks have been carried out.

### PERFORMING A CUT

Performing a cut using a cutting track is very similar to ordinary cutting with a circular saw. All of the safety procedures and protocols that apply to the use of a circular saw will also apply when such a saw is used in conjunction with a cross cutting track.

The following guidelines, though not comprehensive offer some general advice:

- Carry out a safety check to ensure that the Cutting Track is securely fastened to the workpiece, and that the workpiece itself is secure and cannot move during a cut.
- Check to ensure that there are no obstructions under the workpiece that could inhibit or impede the progress of the saw blade or be damaged by the saw blade.
- Ensure that the mains cable is routed in such a way that it does not pose a trip (or any other form) hazard. Check particularly that the mains cable cannot come into contact with the spinning blade of the saw.
- The operator should ensure that when they are pushing the saw along the track they can

maintain a sure footing, good balance and complete control at all times throughout the cut. Particular caution should be exercised as the saw blade exits the workpiece.

**WARNING:** Particularly if working at height (other circumstances may also apply) ensure that any cut material cannot fall away and possibly injure a bystander. The operator may have to consider some way of containing or catching such cut material. Consult the person responsible for site safety for specific guidance.

**Note:** The operator should consider performing a practice run with the saw disconnected from the mains supply to confirm that the cutting procedure will be completely safe throughout.

When the cut has been completed the operator should release the ON/OFF Trigger Switch and allow the motor to stop and the blade to become stationary.

As the saw is lifted from the Cutting Track and workpiece the lower blade guard will automatically deploy covering the blade completely.

### DUST / DEBRIS COLLECTION

An adaptor nozzle (**Fig. 25**) can be fitted to all CCS machines. Fitting the nozzle allows the machine to be connected to a dust/debris collection device.

**Note:** The exact design of the nozzle supplied will vary depending upon type of model and the market destination of the machine. The supplied nozzle will accept a wide variety of debris/dust collection devices currently available. The nozzle should be fitted to the Cut Material Ejection Port. (**Fig. 26**)

**Note:** A workshop dust/debris extraction machine can be attached to the adaptor nozzle if required. Follow the manufacturers instructions if such a machine is fitted and ensure that it is capable of handling the ejected cut material.

## LED LIGHT

Some of these machines (depending upon the model and market destination) are equipped with an automatic LED Light.

**Note:** If you are unsure of which features are provided on your machine, consult the Specification Page provided in this manual.

The LED Light is positioned to the left hand (LH) side of the blade. **(Fig. 27)**

The beam from the LED will light up the left hand side of the blade and also illuminate any marking out lines present on the workpiece. This should help the operator predict the path of the blade through the workpiece and thus aid efficiency, accuracy and safety.

**Note:** Operation of the LED Light is automatic. As soon as the machine is connected to the mains supply the LED will activate. This gives the operator a clear visual indication that the machine has been successfully connected to the mains electrical supply, and is therefore powered (is 'live') and ready for cutting operations to commence.

**Note:** There are no user serviceable parts incorporated within the LED Light assembly and the beam direction is factory set. The protective lens cover should be kept clear of dust etc. (see Maintenance) to ensure the maximum brightness of the projected beam is maintained.

**WARNING:** Only clean the lens cover with the machine disconnected from the mains power supply and the blade completely stationary.

## INTEGRAL CUTTING AIDS

All Evolution circular saws are equipped with various cutting aids or guides designed help the operator achieve quick accurate cuts safely. Note: Not all of the following features will appear on every machine.

### 0° and 45° Line of Cut Guides (Fig. 28)

Located on the front edge of the machines sole plate are two (2) small notches, which on some

machines are identified with an angular number. These notches indicate the position of the blade as it exits the workpiece when the bevel tilt angle is set at 0° (blade vertical) or at an angle of 45°.

### Front of Blade Guide (Fig. 29)

**Note:** Evolution machines compatible with Evolutions Cutting Track have a notch located on the right hand edge (RH) of the sole plate casting. This notch indicates the position of the front edge of the blade when the blade is set at maximum cutting depth. This feature can be used when placing and positioning the saw on a Cutting Track.

**WARNING:** It is important that the lower blade guard or blade do not touch any surface of the workpiece during the initial positioning of the saw on the Cutting Track.

### Ruler Guides (Fig. 30)

Ruler guides are present on some Evolution circular saws. They are positioned along the front and/or side edges of the sole plate. These guides can give a useful approximate position or prediction of the saw blade in the workpiece.

## SPECIALISED ADJUSTMENTS

Your Evolution machine has many precision engineered components and settings, most of which are factory set and adjusted to ensure consistent long term accuracy.

Maintenance and adjustment to these components or settings will probably never be needed. If maintenance or adjustment (after considerable usage) is thought to be necessary Evolution recommend that you contact the technical helpline for further advice and guidance.

**Note:** Certain adjustments procedures are only possible with access to certain specialised knowledge and/or equipment.

## (17) GENERAL CUTTING ADVICE

**WARNING:** The operator must always be

aware of the position and routing of the power cable. The cable must be routed in such a way that there is no possibility of the blade coming into contact with the mains cable.

The cable should not pose a trip (or any other type) of hazard to the operator or any bystanders.

- Do not force the machine.
- Allow the speed of the saw blade do the work. Cutting performance will not be improved by applying excessive pressure to the machine and blade life will be reduced.
- When using the parallel edge guide, ensure that it is parallel with the blade. The blade and/or motor could become damaged if the machine is used with an incorrectly adjusted parallel edge guide.
- Place front edge of sole plate squarely on the workpiece. Before starting the motor ensure that the blade is not in contact with the workpiece.
- When starting a cut, taking care to introduce the blade to the material slowly, so as not to damage blade teeth.

**Note:** Two (2) line of cut guides are provided at the front of the sole plate of the CCSL machine (for 0° and 45° bevel angles only).

- Use both hands to move the saw forwards through the work piece.
- Apply smooth, constant pressure to move the saw forwards through the workpiece.

**Note:** All CCS series machines have an automatic lower blade guard which has a specially shaped leading front edge. This feature ensures that the blade guard retracts smoothly and effortlessly as the machines blade enters the workpiece. As the blade exits the workpiece the lower blade guard will automatically return to its normal position covering the blade completely.

**Note:** On some occasions e.g. making a plunge cut into a floor or wall etc. it may be advantageous to retract the lower blade guard manually.

A thumb operated lever is provided on the lower blade guard. With care, a skilled operator can retract the blade guard

manually, either partially or fully, allowing plunge cuts to be made.

**WARNING:** If retracting the blade guard manually great care must be taken to ensure that the operators hand or fingers do not touch any part of the machines blade.

**When a cut has been completed:**

- Release the ON/OFF Trigger switch.
- Allow the blade to come to a complete stop.
- Remove the machine from the workpiece allowing the lower blade guard to return to its normal position covering the blade.

**WARNING:** If the motor should stop or stall whilst a cut is being attempted release the trigger switch immediately. Disconnect the machine from the power supply and remove the machine from the workpiece. Investigate the cause of the problem and rectify if possible. Only attempt to restart the motor when you are absolutely sure that it is safe to do so.

**CUT MATERIAL EJECTION PORT**

**WARNING:** Do not use the dust bag and dust port adaptor when cutting metallic materials including wood with nails.

**(18) MAINTENANCE & ADJUSTMENTS**

The 0° (blade vertical) position can be adjusted.

**WARNING:** The machine must be disconnected from the mains power supply when attempting this procedure.

**To check 0° position:**

- Set the blade to the 0° position with the tilting mechanism against its stop.
- Check the blade against the sole plate using an engineers precision square (not supplied). Take care to avoid the TCT tips of the teeth. The blade should be at exactly 90° to sole plate.

**Note:** The lower blade guard should be rotated (manually) up into the upper blade guard. This will help accurate positioning of the engineers

square and thus aid the checking process. If adjustment is required:

**R165CCSL & 185CCS**

Turn the adjustment screw (Fig. 31) clockwise or counter clockwise using a 4mm Hex Key (not supplied) until the blade is at exactly 90° to the sole plate.

**R185CCSX & 185CCSX+**

Turn the adjustment screws (Fig. 32) clockwise or counter clockwise using a 3mm Hex Key (not supplied) until the blade is at exactly 90° to the sole plate.

**To check 45° position (R185CCSX & 185CCSX+):**

- Set the blade to the 45° position with the tilting mechanism against its stop.
- Check the blade against the sole plate using an engineers precision square (not supplied). Take care to avoid the TCT tips of the teeth. The blade should be at exactly 45° to sole plate.

Turn the adjustment screws (Fig. 33) clockwise or counter clockwise using a 3mm Hex Key (not supplied) until the blade is at exactly 45° to the sole plate.

**(19) CHECKING AND REPLACING THE CARBON BRUSHES**

**WARNING:** Disconnect the machine from the power supply before attempting to check or replace the Carbon Brushes.

**Note:** Replace both carbon brushes if either has less than 6mm length of carbon remaining, or if the spring or wire is damaged or burned.

**To remove the brushes:**

- Unscrew the plastic caps found at the back of the motor housing. (Fig. 34) Be careful as the caps are spring-loaded.
- Withdraw the brushes with their springs.
- If replacement is necessary renew the brushes and replace the caps.

**Note:** Used but serviceable brushes can be replaced, but only as long as they are returned to the same position, and inserted the same way round as they were

before being removed from the machine.

- Run machines motor without load for approximately 5 minutes. This will help the new brushes to 'bed-in' and ensure that the motor runs efficiently.
- Some sparking may be visible until the brushes bed in fully.

**(20) GENERAL MAINTENANCE & CLEANING**

**Note:** All maintenance must be carried out with the machine switched off and disconnected from the power supply.

- Check that all safety features and guards are operating correctly on a regular basis. Only use this machine if all guards/safety features are fully operational.
- All motor bearings in these machines are lubricated for life. No further lubrication is required.

Use a clean, slightly damp cloth to clean the plastic parts of the machine. Do not use solvents or similar products which could damage the plastic parts. Remove any dust or other contaminants from the lens cover of the LED module.

**WARNING:** Do not attempt to clean by inserting pointed objects through openings in the machines casings etc. The machines air vents should be cleaned using compressed dry air.

**Note:** The operator should employ all necessary PPE when using compressed dry air as a cleaning medium.

**(21) ENVIRONMENTAL PROTECTION**

Waste electrical products should not be disposed of with household waste. Please recycle where facilities exist. Check with your Local Authority or retailer for recycling advice.



## EC DECLARATION OF CONFORMITY



### The manufacturer of the product covered by this Declaration is:

Evolution Power Tools, Venture One, Longacre Close, Holbrook Industrial Estate, Sheffield, S20 3FR.

The manufacturer hereby declares that the machine as detailed in this declaration fulfils all the relevant provisions of the Machinery Directive and other appropriate directives as detailed below. The manufacture further declares that the machine as detailed in this declaration, where applicable, fulfils the relevant provisions of the Essential Health and Safety requirements.

### The Directives covered by this Declaration are as detailed below:

<b>2006/42/EC.</b>	Machinery Directive.
<b>2014/30/EU.</b>	Electromagnetic Compatibility Directive.
<b>2011/65/EU.</b>	The Restriction of the Use of certain Hazardous Substances in Electrical Equipment (RoHS) Directive.
<b>2012/19/EU.</b>	The Waste Electrical and Electronic Equipment (WEEE) Directive.

### And is in conformity with the applicable requirements of the following documents:

**EN 62841-1: 2015 • EN 62841-2-5: 2014 • EN 55014-1: 2017 • EN 55014-2: 2015  
EN 61000-3-2: 2014 • EN 61000-3-3: 2013 (110V models) • EN 61000-3-11: 2000 (220-240V models) • IEC 62321-1.0: 2008**

### Product Details

Description:	<b>R165CCSL</b> 165mm (6-1/2") Circular Saw
Model No:	026-0001 / 026-0002 / 026-0003
Description:	<b>R185CCS</b> 185mm (7-1/4") Circular Saw
Model No:	027-0001C / 027-0002C / 027-0003C
Description:	<b>R185CCSX</b> 185mm (7-1/4") Circular Saw
Model No:	027-0001 / 027-0002 / 027-0003
Description:	<b>R185CCSX+</b> 185mm (7-1/4") Circular Saw
Model No:	027-0001A / 027-0002A / 027-0003A
Brand Name:	EVOLUTION POWER TOOLS LIMITED
Voltages:	110V / 220-240V ~ 50Hz
Input:	R165CCSL - 1200W R185CCS, R185CCSX & R185CCSX+ - 1600W

The technical documentation required to demonstrate that the product meets the requirements of directive has been compiled and is available for inspection by the relevant enforcement authorities, and verifies that our technical file contains the documents listed above and that they are the correct standards for the product as detailed above.

### Name and address of technical documentation holder.

Signed:  Print: Barry Bloomer  
Supply Chain & Procurement Director  
Date: 01/06/18

# evOLUTION®

evolutionpowertools.com

## AUS

Total Tools (Importing) Pty Ltd  
20 Thackray Road  
Port Melbourne  
Vic 3207

T: 03 9261 1900

## FR

Evolution Power Tools SAS  
61 Avenue Lafontaine  
33560, Carbon-Blanc  
Bordeaux

T: +33 (0)5 57 30 61 89

## UK

Evolution Power Tools Ltd  
Venture One, Longacre Close  
Holbrook Industrial Estate  
Sheffield, S20 3FR

T: +44 (0)114 251 1022

## USA

Evolution Power Tools LLC  
8363 Research Drive  
Davenport, IA  
52806

T: 866-EVO-TOOL

**DE** +44 (0)114 251 1022

**ES** +34 91 114 73 85

**NL** +44 (0)114 251 1022

**PL** +48 33 822 09 22

**PT** +34 91 114 73 85

**RO** +44 (0) 114 2050458

**RU** +7 499 350 67 69

**TR** +90 (0) 312 9001810



EPT QR CODE