

# evOLUTION®

evolutionpowertools.com

**R230 RCP**

Original Instructions

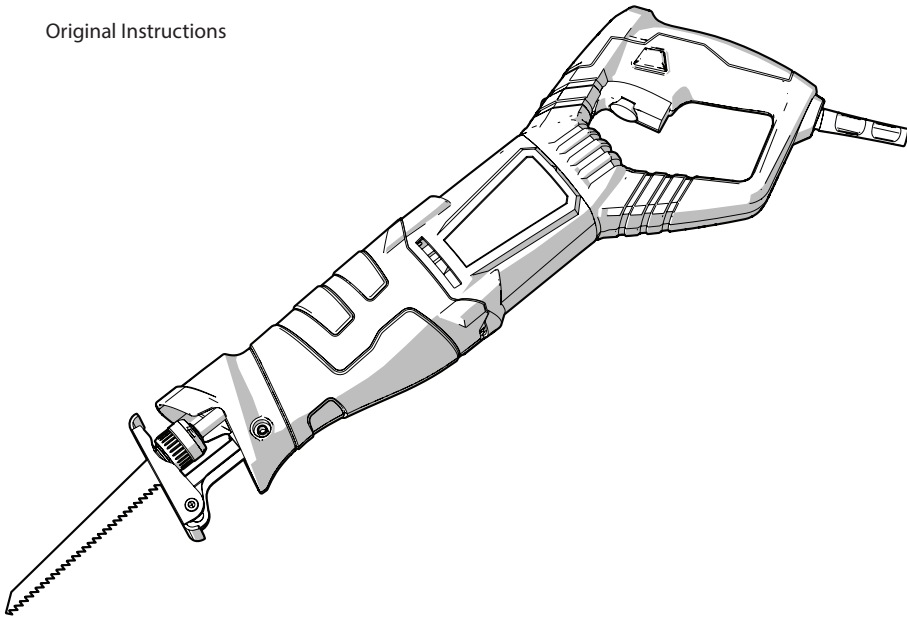

CE  
GB2438285



**TABLE OF CONTENTS**

<b>INTRODUCTION</b>	
Machine Specification	Page 4
Vibration	Page 5
Labels and Symbols	Page 5
Intended use of this Power Tool	Page 6
Prohibited use of this Power Tool	Page 6
<b>SAFETY PRECAUTIONS</b>	
Electrical Safety	Page 7
Outdoor Use	Page 7
General Power Tool Safety Instructions	Page 7
Additional Safety Instructions	Page 9
<b>GETTING STARTED</b>	
Unpacking	Page 10
Machine Overview	Page 11
Operating Instructions	Page 12
<b>MAINTENANCE</b>	
Environmental Protection	Page 17
<b>DECLARATION OF CONFORMITY</b>	<b>Page 18</b>

**THIS INSTRUCTION MANUAL WAS  
ORIGINALLY WRITTEN IN ENGLISH**

**IMPORTANT**

Please read these operating and safety instructions carefully and completely.

For your own safety, if you are uncertain about any aspect of using this equipment please access the relevant technical helpline, the number of which can be found on the Evolution Power Tools website. We operate several helplines throughout our worldwide organization, but technical help is also available from your supplier.

**WEB**

www.evolutionpowertools.com

**EMAIL**

enquiries@evolutionpowertools.com

Congratulations on your purchase of an Evolution Power Tools Machine. Please complete your product registration 'online' as explained in the A5 online guarantee registration leaflet included with this machine. You can also scan the QR code found on the A5 leaflet with a Smart Phone. This will enable you to validate your machine's guarantee period via Evolutions website by entering your details and thus ensure prompt service if ever needed. We sincerely thank you for selecting a product from Evolution Power Tools.

EN

## SPECIFICATIONS

MACHINE SPECIFICATIONS	METRIC	IMPERIAL
Motor EU (230V ~ 50 Hz)	850W	3.7A
Motor USA (120V ~ 60 Hz)	850W	7A
Stroke Length	28mm	1-1/8"
Variable Speed (Strokes Per Minute)	0 - 2800spm	0 - 2800spm
Weight	2.7kg	5.9lbs

CUTTING CAPACITIES	METRIC	IMPERIAL
Mild Steel (Max Thickness)	20mm	3/4"
Wood (Max Thickness)	230mm	9-1/16"
Plastic (Max Thickness)	150mm	5-7/8"

NOISE & VIBRATION DATA	
Sound Pressure $L_{PA}$ (Under Load)	90.39 dB(A) K=3dB(A)
Sound Power Level $L_{WA}$ (Under Load)	101.39 dB(A) K=3dB(A)
Vibration Level (Under Load) - Main Handle	Wood - 10.357m/s <sup>2</sup> , Metal - 21.223m/s <sup>2</sup> K=1.5m/s <sup>2</sup>
Vibration Level (Under Load) - Auxiliary Handle	Wood - 19.151m/s <sup>2</sup> , Metal - 19.905m/s <sup>2</sup> K=1.5m/s <sup>2</sup>

**Note:** The vibration measurement was made under standard conditions in accordance with: **EN 62841-1:2015**

**The declared vibration total value has been measured in accordance with a standard test method and may be used for comparing one tool with another.**

**The declared vibration total value may also be used in a preliminary assessment of exposure.**

#### **VIBRATION**

**WARNING:** When using this machine the operator can be exposed to high levels of vibration transmitted to the hand and arm. It is possible that the operator could develop "Vibration white finger disease" (Raynaud syndrome). This condition can reduce the sensitivity of the hand to temperature as well as producing general numbness. Prolonged or regular users of this machine should monitor the condition of their hands and fingers closely. If any of the symptoms become evident, seek immediate medical advice.

- The measurement and assessment of human exposure to hand-transmitted vibration in the workplace is given in: **BS EN ISO 5349-1:2001** and **BS EN ISO 5349-2:2002**
- Many factors can influence the actual vibration level during operation e.g. the work surfaces condition and orientation and the type and condition of the machine being used. Before each use, such factors should be assessed, and where possible appropriate working practices adopted. Managing these factors can help reduce the effects of vibration:

#### **Handling**

- Handle the machine with care, allowing the machine to do the work.
- Avoid using excessive physical effort on any of the machines controls.
- Consider your security and stability, and the orientation of the machine during use.

#### **Work Surface**



- Consider the work surface material; its condition, density, strength, rigidity and orientation.

**WARNING:** The vibration emission during actual use of the power tool can differ from the declared total value depending on the ways in which the tool is used. The need to identify safety measures and to protect the operator are based on an estimation of exposure in the actual conditions of use (taking account of all parts of the operating cycle, such as the times the tool is switched off, when it is running idle, in addition to trigger time).

#### **LABELS & SYMBOLS**

**WARNING:** Do not operate this machine if warning and/or instruction labels are missing or damaged. Contact Evolution Power Tools for replacement labels.

**Note:** All or some of the following symbols may appear in the manual or on the product.

Symbol	Description
V	Volts
A	Amperes
Hz	Hertz
Min <sup>-1</sup>	Speed
~	Alternating Current
n <sub>0</sub>	No Load Speed
	Wear Safety Goggles
	Wear Ear Protection
	Wear Dust Protection
	Read Instructions
	Double Insulation Protection
	CE Certification
	CSA Certification
	Waste Electrical & Electronic Equipment
	Warning

**INTENDED USE OF THIS POWER TOOL**

**WARNING:** This product is a hand held reciprocating saw and has been designed to be used with special Evolution blades. Only use accessories designed for use in this machine and/or those recommended specifically by Evolution Power Tools Ltd.

**When fitted with an appropriate blade, and with the workpiece contact plate firmly on the workpiece, this machine can be used to cut:**

Wood  
Mild Steel, Aluminium, and many other non-ferrous metals.  
Most plastics.

**PROHIBITED USE OF THIS POWER TOOL**

**WARNING:** This product is a hand held reciprocating saw and must only be used as such. It must not be modified in any way, or used to power any other equipment or drive any other accessories other than those mentioned in this instruction manual.

**WARNING:** This machine must not be used to cut any material that may contain asbestos. If the presence of asbestos is suspected, consult the relevant authorities for advice.

**WARNING:** This machine is not intended for use by persons (including children) with reduced physical, sensory or mental capabilities, or lack of experience and knowledge, unless they have been given supervision or instruction concerning the safe use of the machine by a person responsible for their safety and who is competent in its safe use.

Children should be supervised to ensure that they do not have access to, and are not allowed to play with, this machine.

## **ELECTRICAL SAFETY**

**This machine is fitted with the correct moulded plug and mains lead for the designated market. If the mains lead or the plug are damaged in any way, they must be replaced with original replacement parts by a competent technician.**

## **OUTDOOR USE**

**WARNING:** For your protection if this tool is to be used outdoors it should not be exposed to rain, or used in damp locations. Do not place the tool on damp surfaces. Use a clean, dry workbench if available. For added protection use a residual current device (R.C.D.) that will interrupt the supply if the leakage current to earth exceeds 30mA for 30ms. Always check the operation of the residual current device (R.C.D.) before using the machine.

If an extension cable is required it must be a suitable type for use outdoors and so labelled. The manufacturers instructions should be followed when using an extension cable.

## **POWER TOOL GENERAL SAFETY INSTRUCTIONS**

(These General Power Tool Safety Instructions are as specified in EN 62841-1:2015, EN 62841-2-11:2016)

**WARNING:** Read all safety warnings and instructions. Failure to follow the warnings and instructions may result in electric shock, fire and/or serious injury.

**Save all warnings and instructions for future reference. The term "power tool" in the warnings refers to your mains-operated (corded) power tool or battery-operated (cordless) power tool.**

### **1) General Power Tool Safety Warnings [Work Area Safety]**

**a) Keep work area clean and well lit.**

Cluttered or dark areas invite accidents.

**b) Do not operate power tools in explosive atmospheres, such as in the presence**

**of flammable liquids, gasses or dust.**

Power tools create sparks which may ignite the dust or fumes.

**c) Keep children and bystanders away while operating power tool.**

Distractions can cause you to lose control.

## **2) General Power Tool Safety**

### **Warnings [Electrical Safety]**

**a) Power tool plugs must match the outlet.**

**Never modify the plug in any way. Do not use any adapter plugs with earthed (grounded) power tools.** Unmodified plugs and matching outlets will reduce the risk of electric shock.

**b) Avoid body contact with earthed or grounded surfaces, such as pipes, radiators, ranges and refrigerators.**

There is an increased risk of electric shock if your body is earthed or grounded.

**c) Do not expose power tools to rain or wet conditions.** Water entering a power tool will increase the risk of electric shock.

**d) Do not abuse the cord. Never use the cord for carrying, pulling or unplugging the power tool. Keep cord away from heat, oil, sharp edges or moving parts.** Damaged or entangled cords increase the risk of electric shock.

**e) When operating a power tool outdoors, use an extension cord suitable for outdoor use.**

Use of a cord suitable for outdoor use reduces the risk of electric shock.

**f) If operating a power tool in a damp location is unavoidable, use a residual current device (RCD) protected supply.**

Use of an RCD reduces the risk of electric shock.

## **3) General Power Tool Safety**

### **Warnings [Personal Safety].**

**a) Stay alert, watch what you are doing and use common sense when operating a power tool.**

Do not use a power tool while you are tired or under the influence of drugs, alcohol or medication. A moment of inattention while operating power tools may result in serious personal injury.

**b) Use personal protective equipment.**

Always wear eye protection. Protective

equipment such as dust masks, non-skid safety shoes, hard hat or hearing protection used for appropriate conditions will reduce personal injuries.

**c) Prevent unintentional starting.**

Ensure the switch is in the off-position before connecting to power source and or battery pack, picking up or carrying the tool. Carrying power tools with your finger on the switch or energising the power tools that have the switch on invites accidents.

**d) Remove any adjusting key or wrench before turning the power tool on.**

A wrench or key left attached to a rotating part of a power tool may result in personal injury.

**e) Do not overreach. Keep proper footing and balance at all times.** This enables better control of the power tool in unexpected situations.

**f) Dress properly. Do not wear loose clothing or jewelry.** Keep your hair, clothing and gloves away from moving parts. Loose clothes, jewelry or long hair can be caught in moving parts.

**g) If devices are provided for the connection of dust extraction and collection facilities, ensure that these are connected and properly used.** Use of dust collection can reduce dust-related hazards.

**4) General Power Tool Safety Warnings [Power Tool Use and Care].**

**a) Do not force the power tool. Use the correct power tool for your application.**

The correct power tool will do the job better and safer at a rate for which it was designed.

**b) Do not use the power tool if the switch does not turn it on or off.** Any power tool that cannot be controlled with the switch is dangerous and must be repaired.

**c) Disconnect the power tool from the power source and/or battery pack from the power tool before making any adjustments, changing accessories, or storing power tools.** Such preventative safety measures reduce the risk of starting the power tool accidentally.

**d) Store idle power tools out of the reach of**

**children and do not allow persons unfamiliar with the power tool or these instructions to operate the power tool.** Power tools are dangerous in the hands of untrained users.

**e) Maintain power tools.** Check for misalignment or binding of moving parts, breakage of moving parts and any other condition that may affect the power tools operation. If damaged, have the power tool repaired before use. Many accidents are caused by poorly maintained power tools.

**f) Keep cutting tools sharp and clean.** Properly maintained cutting tools with sharp cutting edges are less likely to bind and are easier to control.

**g) Use the power tool, accessories and tool bits, etc, in accordance with these instructions, taking into account the working conditions and the work to be performed.** Use of the power tool for operations different from those intended could result in a hazardous situation.

**5) General Power Tool Safety Warnings [Service]**

**a) Have your power tool serviced by a qualified repair person using only identical replacement parts.** This will ensure that the safety of the power tool is maintained.

**HEALTH ADVICE**

**WARNING:** When using this machine, dust particles may be produced. In some instances, depending on the materials you are working with, this dust can be particularly harmful.

If you suspect that paint on the surface of material you wish to cut contains lead, seek professional advice. Lead based paints should only be removed by a professional and you should not attempt to remove it yourself. Once the dust has been deposited on surfaces, hand to mouth contact can result in the ingestion of lead. Exposure to even low levels of lead can cause irreversible brain and nervous system damage. The young and unborn children are particularly vulnerable.



You are advised to consider the risks associated with the materials you are working with and to reduce the risk of exposure. As some materials can produce dust that may be hazardous to your health, we recommend the use of an approved face mask with replaceable filters when using this machine.

**You should always:**

- Work in a well-ventilated area.
- Work with approved safety equipment, such as dust masks that are specially designed to filter microscopic particles.

**WARNING:** The operation of any power tool can result in foreign objects being thrown towards your eyes, which could result in severe eye damage. Before beginning power tool operation, always wear safety goggles or safety glasses with side shield or a full face shield where necessary.

**ADDITIONAL SAFETY INSTRUCTIONS**

**WARNING:** Always disconnect the reciprocating saw from the mains supply before changing blades, servicing, cleaning or adjusting the reciprocating saw.

- Keep your hands away from the cutting area and the cutting blade. Hold the machine by gripping the insulated hand - hold areas with both hands. If both hands are holding the machine, they cannot come into contact with the blade.
- Do not use dull or damaged blades. Dull or damaged blades can break easily and are prone to 'jamming' which can cause 'kickback'.
- Always check that the blade is correctly installed within the machines blade holder. Wear protective gloves when handling a blade and conduct a 'tug test' when a new blade is installed to ensure the blade has been successfully 'captured' by the blade holder.
- Do not use excessive force. Excessive force overloads the motor and reduces working efficiency and service life.
- Always wear the relevant PPE (Personal

Protective Equipment) for the job at hand. This could typically include safety glasses or eye shields, dust masks, protective clothing and safety shoes, ear defenders and safety helmet, etc.

- The operator should always be aware of the routing of the mains power cable. The cable should be routed in such a way that it cannot become a trip or other type of hazard and cannot come into contact with the machines blade.
- Always check walls, floors and ceilings for hidden power cables, water and/or gas pipes or other services. Striking hidden services could be extremely dangerous to the operator, and could cause considerable property damage. Detectors that can determine the position of hidden utilities within or behind a wall, etc, are readily available at most tool retailers.
- Only withdraw the blade from a cut when the machine has been switched 'off', and the blade has come to a complete stop. Withdrawing a moving blade from a cut could lead to the moving blade striking a nearby surface causing the operator to experience severe 'kickback'.
- If possible, ensure that any work-piece is firmly clamped to prevent movement during the cutting operation.
- Never try to stop the cutting blade by applying sideways pressure to the blade. Allow the blade come to a halt by turning the machine 'Off', allowing the motor to slow and stop normally.
- Always check that the mains supply voltage is the same as the indicated supply voltage shown on the machines rating plate. Using this machine with a supply voltage that is different from that shown on the machines rating plate could damage the machine and could potentially cause the machine to be electrically unsafe.

- Do not alter or modify the power cord. This saw is equipped with an approved cord and plug for its intended country of use. If the moulded plug or the power cord is damaged in any way it must be replaced with an identical type by a competent technician.

**WARNING:** This machine must not be used to cut any material that may contain asbestos. If the presence of asbestos is suspected, consult the relevant authorities for advice. Do not attempt to cut any suspect material until it has been declared safe to do so by the relevant authorities.

### GETTING STARTED

#### UNPACKING

**Caution:** This packaging contains sharp objects. Take care when unpacking. Remove the machine, together with the accessories supplied from the packaging. Check carefully to ensure that the machine is in good condition and account for all the accessories listed in this manual. Also make sure that all the accessories are complete. If any parts are found to be missing, the machine and its accessories should be returned together in their original packaging to the retailer. Do not throw the packaging away; keep it safe throughout the guarantee period. Dispose of the packaging in an environmentally responsible manner. Recycle if possible. Do not let children play with empty plastic bags due to the risk of suffocation.

### ITEMS SUPPLIED

Description	Quantity
R230RCP Reciprocating Saw	1
<b>Multipurpose Blade 2 Pack</b> (Includes 1 x Thin Steel & 1 x Multipurpose Blade)	1
<b>Wood Cutting Blade 2 Pack</b> (Includes 1 x Green Wood & 1 x General Wood Blade)	1
Instruction Manual	1

### ADDITIONAL ACCESSORIES

In addition to the standard items supplied with this machine, the following accessories are also available from the Evolution online shop at [www.evolutionpowertools.com](http://www.evolutionpowertools.com) or from your local retailer.

Description	Part No
<b>Multipurpose Blade Pack 2</b> (Includes 1 x Thin Steel & 1 x Multipurpose Blade)	045-0255
<b>Wood Cutting Blade Pack 2</b> (Includes 1 x Green Wood & 1 x General Wood Blade)	045-0254

### MACHINE OVERVIEW

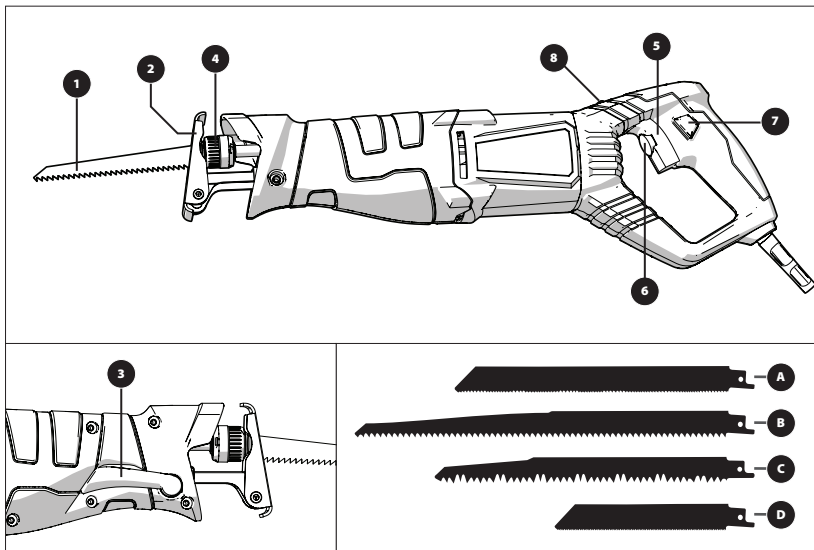

- 1. Blade
- 2. Workpiece Contact Plate
- 3. Contact Plate Locking Lever
- 4. Blade Clamp Dial
- 5. Trigger Switch
- 6. Variable Speed Control
- 7. Trigger Lock-On Button
- 8. Handle Rotation Button

- A. Multipurpose Blade
- B. General Wood Blade
- C. Green Wood Blade
- D. Thin Steel Blade

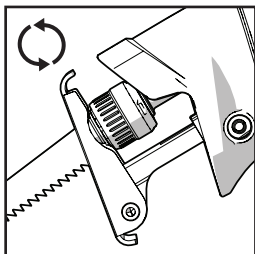

**Fig. 1**

**INSTALLING OR REMOVING A BLADE**

**WARNING:** Only attempt these procedures with the machine disconnected from the mains power supply.

**Note:** We recommend that the operator wears protective gloves when handling blades. Care should be exercised as a recently used blade could be hot and/or contaminated with debris.

**To install a blade:**

- Ensure that the blade holder is clean and free from debris or other contaminants.
- Twist and hold the blade clamping dial anti-clockwise.

**(Fig. 1)**

- Fully insert the shank of the blade into the blade holder.
- Release the blade clamp so it returns to its original position.
- Check that the blade is secure.

**WARNING:** It is important that the hole in the tang of the blade engages with the 'spigot' located inside the blade holder.

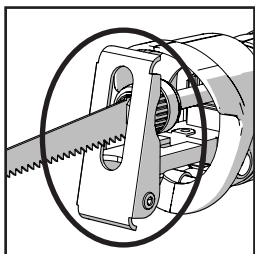

**Fig. 2**

**To remove a blade:**

- If recently used allow the blade to cool down.
- Ensure that the machine is facing downwards to allow any debris to fall out.
- Twist and hold the blade clamping dial anti-clockwise.
- Gently pull the blade from the blade holder.

**Note:** If a blade is being removed because it is at the end of its service life eject it straight into a recycling bin.

**WORKPIECE CONTACT PLATE (Fig. 2)**

**WARNING:** To achieve the best cutting efficiency, minimise the risk of vibration, and blade jumping and/or breakage, the workpiece contact plate must be kept firmly in contact with the workpiece.

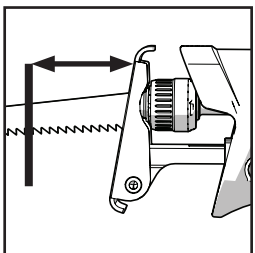

**Fig. 3**

**Note:** The workpiece contact plate is pivoted and adjustable. This feature allows the contact plate to adjust and lie flush on a workpiece surface even when the machines main body is at a slight angle to that surface.

**CUTTING REACH & CAPACITY**

By using different length blades and/or altering the service position of the workpiece contact plate, it is possible to increase or decrease the overall 'reach' and cutting capacity of the machine.

**(Fig. 3)**

**To adjust the position of the contact plate:**

- Release the contact plate locking lever. **(Fig. 4)**
- Pull out or push in the contact plate as required.
- Once the plate is in the desired position, push the locking lever back into its original position to lock the plate in place.
- Check that it is secure.

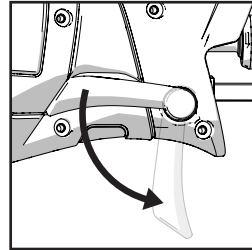

**Fig. 4**

**THE TRIGGER SWITCH**

The ON/OFF trigger switch is located within the machines rear handle. **(Fig. 5).**

- Squeeze the trigger switch to start the machines motor.
- Release the trigger switch to stop the machines motor.

**LOCK-ON SWITCH**

The trigger is equipped with a lock-on switch. To operate the lock-on feature:

- Fully squeeze the trigger to start the machines motor.
- Press and hold the lock-on switch. **(Fig. 6)**
- Release the trigger then release the lock-on switch.

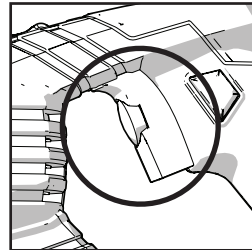

**Fig. 5**

**WARNING:** The motor will run continuously until the trigger is pressed and the lock-on switch is tripped.

**THE STROKE RATE CONTROL DIAL**

The stroke rate of the machine can be varied. A stroke rate control dial is located on the trigger. **(Fig. 7).**

**Note:** The ergonomic positioning of this control dial allows a skilled operator to adjust the stroke rate of the machine during cutting operations.

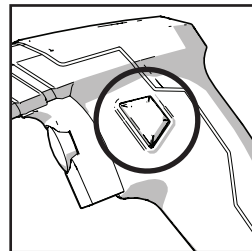
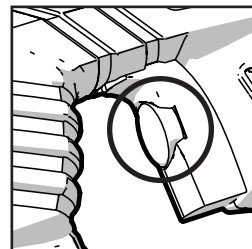

**Fig. 6**

Rotating this dial will alter the stroke rate of the machine from approximately 800 strokes a minute up to a maximum of 2800 strokes per minute.

**Note:** We recommend that the operator begins any cutting operation using a slow stroke rate, and increases the stroke rate to achieve optimum performance as cutting progresses.

A practical trial on scrap material may be useful to determine the best stroke rate for any particular material or application.



**Fig. 7**

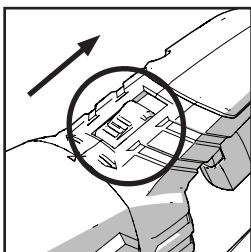

**Fig. 8**

**180° ROTATING HANDLE**

The handle of the machine can be rotated through 180° and has 3 positions to achieve maximum control during cutting.

**To rotate the handle:**

- Slide and hold the handle rotation button backwards. **(Fig. 8)**
- Twist the handle through 90° into the desired position.
- Release the rotation button.
- Check the handle is secure and the button is fully engaged.

**WARNING:** Handle adjustments must only be made when the motor is off. Adjusting the handle while the tool is in use can lead to serious injury.

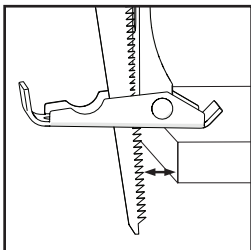

**Fig. 9**

**GENERAL CUTTING**

**WARNING:** Never start the machine with the blade in contact with the workpiece.

- Select a low stroke rate.
- Hold the machine with both hands.
- Ensure that the workpiece contact plate is firmly in contact with the workpiece but that the blade is not. **(Fig. 9).**
- Switch on the machine.
- Very gradually, and holding the machine firmly, introduce the blade into the workpiece until it is cutting successfully.
- Operate the stroke rate control dial until optimum cutting performance is achieved.
- Never 'force' the blade. Allow the blade to cut through the workpiece without applying undue pressure. Forcing the blade will reduce blade life, increase the likelihood of blade breakage, and put strain on the machines motor.

**WARNING:** If the saw blade should jam, switch off the machine immediately and disconnect from the mains supply.

**JAMMED BLADES**

**WARNING:** Jammed blades may be very hot and/or contaminated with debris. The operator should exercise great caution when attempting to remove a 'jammed' blade, and employ all necessary PPE.

To remove a jammed blade the kerf (the saw cut made by the blade) will have to be widened.

- Remove the machine from the blade by operating the blade clamping dial, and carefully easing the machine from the jammed blade.
- Widen the kerf with a suitable tool until the blade can be pulled from the workpiece.

### PLUNGE CUTTING

**WARNING:** Plunge cutting is a technique that must only be used on soft building materials such as plasterboard etc. It is not a suitable procedure for use on harder materials, and must never be employed on metallic materials.

**Note:** This technique should not be attempted by inexperienced operatives.

**Note:** Only dedicated plunge cutting blades must be used when attempting a plunge cut.

**Note:** To reduce the risk of blade kickback when plunge cutting. It is recommended to drill a pilot hole and plunge cut into the hole as a starting point, giving you extra control and stability.

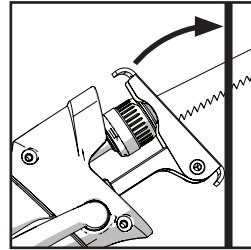

Fig. 10

#### To plunge cut:

- Complete any/all marking out of the cutting lines using a pencil, marker pen, etc, on the workpiece before commencing operations.
- Hold the machine at an angle to the workpiece with the bottom edge of the workpiece contact plate resting firmly against the workpiece. (Fig. 10).

**Note:** The blade must not be in contact with the workpiece at this stage. The operator must also be satisfied that the blade will not contact the workpiece immediately the machine is switched on.

- Set stroke rate to its maximum setting.
- Switch the machine on.
- Very slowly rotate the machine using the bottom edge of the workpiece contact plate as a fulcrum. Allow the blade to very gradually ingress into the workpiece.
- When the contact plate is lying flat against the workpiece continue cutting as normal.
- Adjust the stroke rate for optimum cutting performance.

### FLUSH CUTTING

Flush cutting is cutting very close to a surface such as a floor, wall or ceiling etc. This technique allows the operator to cut off unwanted protruding material such as redundant joists, brackets pipes, etc, from a building.

**WARNING:** The operator should ensure that any redundant architectural objects etc, are not 'live' and it is safe to cut through them.

**Note:** Flush cutting is only possible when using highly flexible bi-metal blades.

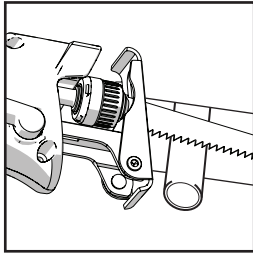

**Fig. 11**

**To flush cut:**

- Select and insert the correct saw blade into the machine.
- Position the side of saw blade directly against the floor, wall, etc.
- A side edge of the workpiece contact plate should be in contact with the floor, wall, etc.
- Switch on the machine and gradually introduce the blade into the workpiece.
- Adjust the stroke rate for optimum performance.
- Cut through the workpiece slowly allowing the flexible blade to curve as required. **(Fig. 11).**
- Allow the side of the flexible blade to gently glide across the floor, wall, etc.

**CLEANING**

**WARNING:** Any cleaning must only be attempted with the machine disconnected from the mains power supply.

Clean the saw blade holder and remove any dirt and/or debris build up. The saw blade should be removed from the machine to facilitate proper and thorough cleaning.

Remove any contaminants by using a soft haired brush. Compressed air can also be used. If this is the case the operator should take all the necessary safety precautions to safeguard the surrounding environment and any bystanders that may be present. The operator should use all relevant PPE.

Safety glasses should be worn to protect the operators eyes from blown debris.

**MAINTENANCE**

**WARNING:** Any maintenance must be carried out with the machine switched off and disconnected from the mains/battery power supply.

Check that all safety features and guards are operating correctly on a regular basis. Only use this machine if all guards/safety features are fully operational.

All motor bearings in this machine are lubricated for life. No further lubrication is required.

Use a clean, slightly damp cloth to clean the plastic parts of the machine. Do not use solvents or similar products which could damage the plastic parts.



**WARNING:** Do not attempt to clean by inserting pointed objects through openings in the machines casings, etc. The machines air vents should be cleaned using compressed dry air.

Excessive sparking may indicate the presence of dirt in the motor or worn out carbon brushes.

If this is suspected have the machine serviced and the brushes replaced by a qualified technician.

**ENVIRONMENTAL PROTECTION**

Waste electrical products should not be disposed of with household waste. Please recycle where facilities exist.

Check with your local authority or retailer for recycling advice.



**EC DECLARATION OF CONFORMITY**

In accordance with EN ISO 17050-1:2004

**The manufacturer of the product covered by this declaration is:****UK:** Evolution Power Tools Ltd, Venture One, Longacre Close, Holbrook Industrial Estate, Sheffield, S20 3FR.**FR:** Evolution Power Tools SAS, 61 Avenue Lafontaine, 33560, Carbon-Blanc, Bordeaux, France.

The manufacturer hereby declares that the machine as detailed in this declaration fulfils all the relevant provisions of the Machinery Directive and other appropriate directives as detailed below. The manufacture further declares that the machine as detailed in this declaration, where applicable, fulfils the relevant provisions of the Essential Health and Safety requirements.

**The Directives covered by this Declaration are as detailed below:**

<b>2006/42/EC</b>	Machinery Directive.
<b>2014/30/EU</b>	Electromagnetic Compatibility Directive.
<b>2011/65/EU. &amp; 2015/863/EU.</b>	The Restriction of the Use of certain Hazardous Substances in Electrical Equipment (RoHS) Directive.
<b>2002/96/EC as amended by 2003/108/EC</b>	The Waste Electrical and Electronic Equipment (WEEE) Directive.

**And is in conformity with the applicable requirements of the following documents:**

**EN 62841-1:2015, EN 62841-2-11:2016, EN 55014-1:2017, EN 55014-2:2015, EN 61000-3-2:2014, EN 61000-3-3:2013**

**Product Details**

Description:	R230RCP RECIPROCATING SAW
Evolution Model No:	045-0001 (230V UK), 045-0003 (230V EU), 045-0004 (120V US)
Brand Name:	EVOLUTION
Voltage:	230V ~ 50 Hz, 120V ~ 60 Hz
Input:	850W

The technical documentation required to demonstrate that the product meets the requirements of directive has been compiled and is available for inspection by the relevant enforcement authorities, and verifies that our technical file contains the documents listed above and that they are the correct standards for the product as detailed above.

**Name and address of technical documentation holder.**Signed:  Print: Barry Bloomer - Supply Chain & Procurement Director

Date: 20/06/2019

**UK:** Evolution Power Tools Ltd, Venture One, Longacre Close, Holbrook Industrial Estate, Sheffield, S20 3FR.**FR:** Evolution Power Tools SAS, 61 Avenue Lafontaine, 33560, Carbon-Blanc, Bordeaux, France.



# evOLUTION®

evolutionpowertools.com

## AUS

Total Tools (Importing) Pty Ltd  
20 Thackray Road  
Port Melbourne  
Vic 3207

T: 03 9261 1900

## FR

Evolution Power Tools SAS  
61 Avenue Lafontaine  
33560, Carbon-Blanc  
Bordeaux

T: +33 (0)5 57 30 61 89

## UK

Evolution Power Tools Ltd  
Venture One, Longacre Close  
Holbrook Industrial Estate  
Sheffield, S20 3FR

T: +44 (0)114 251 1022

## USA

Evolution Power Tools LLC  
8363 Research Drive  
Davenport, IA  
52806

T: 1-833-MULTI SAW (TOLL FREE)

**DE** +44 (0)114 251 1022

**ES** +34 91 114 73 85

**NL** +44 (0)114 251 1022

**PL** +48 33 822 09 22

**PT** +34 91 114 73 85

**RO** +44 (0) 114 2050458

**RU** +33 (0)5 57 30 61 89

**TR** +90 (0) 312 9001810



EPT QR CODE

V1 - BK1